



**Classic Owner's Manual**  
Strength Systems



Part No. 4910 0698

Disclaimer:

Cybex International, Inc., makes no representations or warranties regarding the contents of this manual. We reserve the right to revise this document at any time or to make changes to the product described within it without notice or obligation to notify any person of such revisions or changes.

©Copyright 1993, 1994, 1995, 1996, 1997, 1998 Cybex International, Inc. All rights reserved.  
Printed in the United States of America.

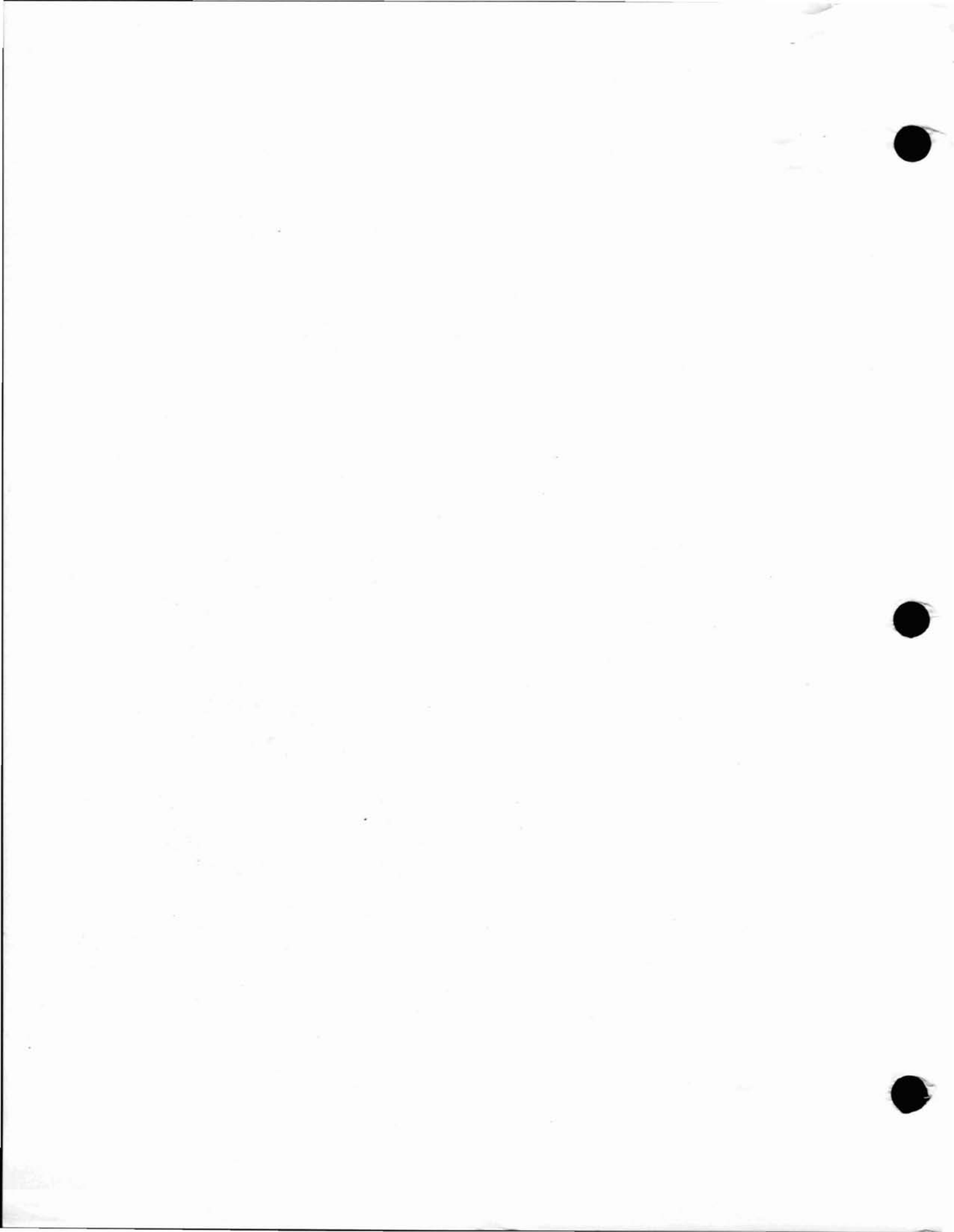

# TABLE OF CONTENTS

## 1 GENERAL EXERCISE GUIDELINES

General Exercise Guidelines .....	1-1
Glossary .....	1-2
Exercise Charts	
Single Set Exercise Chart .....	No Page Number
Multiple Set Exercise Chart .....	No Page Number

## 2 EXERCISES

Pullover .....	4000
Lat Pulldown .....	4005
Rowing .....	4010
Chest Press .....	4015
Fly .....	4022
Shoulder Press .....	4025
Lateral Raise .....	4031
Tricep Extension .....	4035
Arm Curl .....	4040
Tricep Press .....	4055
Incline Press .....	4060
Leg Extension .....	4105, 4108 with RLD
Leg Curl .....	4110, 4113 with RLD
Standing Calf Raise .....	4117
Multi Hip .....	4121
Seated Leg Curl .....	4132
Hip Adduction .....	4140
Hip Abduction .....	4145
Rotary Torso .....	4201
Back Extension .....	4205, 4208 with RLD
Abdominal .....	4212

## 3 CUSTOMER SERVICE

Ordering Parts .....	3-1
CYBEX Limited Warranty .....	3-1

## 4 DELIVERY & INSTALLATION

Delivery Inspection .....	4-1
Installation .....	4-1
Anchoring .....	4-2
Safety .....	4-2
Weight Stack Installation .....	4-3
Servicing Weight Stacks .....	4-4

## 5 MAINTENANCE

Caution Statement .....	5-1
Daily Procedures .....	5-1
Weekly Procedures .....	5-3
Yearly Procedures .....	5-5
"As Required" Procedures .....	5-5
Cable Adjustment .....	5-5
Cable Tension Check .....	5-7
Alternative Cable Tension Check .....	5-7
Cable Tension - Jam Nut Adjustment .....	5-8
Cable Tension - Rod End Adjustment .....	5-9
Cable Tension - Roll Pin Adjustment .....	5-10
Cable Tension - Nylon Insert Nut Adjustment .....	5-11

## 6 SERVICE

General .....	6-1
Caution Statement .....	6-1
Grip Replacement .....	6-1
Pullover .....	4000
Lat Pulldown .....	4005
Rowing .....	4010
Chest Press .....	4015
Fly .....	4022
Shoulder Press .....	4025
Lateral Raise .....	4031
Tricep Extension .....	4035
Arm Curl .....	4040
Tricep Press .....	4055
Incline Press .....	4060
Leg Extension .....	4105, 4108 with RLD
Leg Curl .....	4110, 4113 with RLD
Standing Calf Raise .....	4117
Multi Hip .....	4121
Seated Leg Curl .....	4132
Hip Adduction .....	4140
Hip Abduction .....	4145
Rotary Torso .....	4201
Back Extension .....	4205, 4208 with RLD
Abdominal .....	4212

## CHAPTER 1 - GENERAL EXERCISE GUIDELINES

### General

Like any sport, strength training involves an element of risk. The following recommendations will help to ensure that training is as productive and safe as possible.

Prior to embarking on any strength training program, it is recommended that each user consult with a physician.

All training sessions should be supervised by trained personnel.

Be sure all warning labels are read and understood by each user.

It is very important that all users be instructed on the proper use of CYBEX Strength Systems products. Pay close attention to the following:

- Set up and alignment for each individual entry and exit from the unit
- Proper form
- Use of seat belts, safety catches and other safety features

To minimize the chance of injury:

- Do not lean on the weight stack or other moving parts
- Keep clear of safety catches, belts and pulleys
- Have a spotter present
- Do not exceed any exercise or movement restrictions prescribed by a doctor, therapist or trainer. This is particularly important for those at risk due to:
  - Known heart disease
  - Known hypertension
  - Obesity

Instruct all users to report any equipment irregularity or personal injury to supervisory personnel immediately.

**Glossary**

- Acceleration** - the rate at which an object's velocity changes with time; that is the change of velocity divided by the time interval.
- Accuracy** - freedom from error. Degree of conformity of a measure to a standard or a true value.
- Adipose tissue** - fat tissue.
- Aerobic** - utilizing oxygen.
- Aerobic endurance** - the ability to persist in physical activities that rely heavily upon oxygen for energy production.
- Anabolic** - pertaining to the synthesis of complex substances from simpler substances, especially to the synthesis of body proteins from amino acids.
- Anaerobic** - without oxygen.
- Anaerobic endurance** - the ability to persist in physical activities of short duration that require high rates of energy expenditure. These high rates of energy expenditure cannot be met solely by aerobic metabolism.
- Anthropometrics** - measurements and relationships of length and girth of body parts.
- Atrophy** - reduction in size of cells and tissues.
- Body composition** - the component parts of the body - mainly fat and fat-free weight.
- Calorie** - a unit of work or energy equal to the amount of heat required to raise the temperature of 1 g of water to 1 degree C.
- Cam** - a mechanical device used to vary leverage.
- Carbohydrate** - a chemical compound consisting of carbon, hydrogen and oxygen atoms in specified arrangements. Carbohydrates are major components of food such as bread, potatoes and rice.
- Cardiovascular** - pertaining to the heart and blood vessels.

- Circuit Training** - a conditioning program consisting of a number of exercises performed at "stations". Usually, a given exercise is performed at a station within a specified time; then the athlete moves to the next station, with its own particular exercise and specified time, then to the next station, and so on.
- Collagen** - a fibrous protein that serves as the major component of ligaments and tendons.
- Concentric action** - contraction of a muscle resulting in shortening of the muscle.
- Cross bridges** - the linkages between actin and myosin filaments during muscle contraction.
- Eccentric action** - a muscle contraction incapable of overcoming the resistance imposed; the overall muscle length increases.
- Endurance** - the ability to persist in performing some physical activity.
- Energy** - the capacity to perform work.
- Energy (kinetic)** - energy associated with motion.
- Energy (potential)** - energy by virtue of position.
- Energy system** - one of three metabolic systems involving a series of chemical reactions resulting in the formation of waste products and the manufacture of ATP.
- Ergometer** - a device which can measure work done, e.g., a bicycle ergometer.
- Fast twitch fibers** - skeletal muscle fibers most active in short-duration, intensive exercise, e.g., in sprints and jumps.
- Fatigue** - the inability to maintain a given level of physical performance.
- Flexibility** - the range of motion of the body's joints.
- Foot-pound** - the work required to move one pound of resistance one foot in distance.

## *CYBEX Classic Owner's Manual*

- Force** - a push or pull exerted upon some object; an action exerted by one body on another that tends to change the state of motion of the body acted upon.
- Hypertrophy** - increased cell size leading to increased tissue size.
- Inertia** - the property of an object that allows it to stay in rest or motion. An object with high inertia is difficult to set in motion. Once in motion, it is difficult to stop.
- Intermittent work** - work sessions interrupted by rest sessions.
- Isokinetic contraction** - a muscular contraction through a range of motion at a constant velocity.
- Isometric (static) contraction** - a muscular contraction in which there is no change in the angle of the involved joint(s) and little or no change in the length of the contracting muscle.
- Isotonic contraction** - a muscular contraction in which a constant resistance is moved through a range of motion of the involved joint(s).
- Kilocalorie** - a unit of work or energy equal to the amount of heat required to raise the temperature of 1 kg of water 1 degree C.
- Kinetic energy** - energy associated with motion.
- Lactic acid (lactate)** - the end-product of anaerobic glycolysis.
- Lean body mass** - the body mass that does not include fat tissue.
- Ligament** - the tough connective tissue that binds bones together at joints.
- Mass** - the amount of matter an object contains, or the number of atoms. Unlike weight, an objects mass is constant, despite the value of gravitational acceleration. Mass is a determiner of an object's inertia.
- Metabolism** - the sum total of the chemical changes or reactions occurring in the body.



## *CYBEX Classic Owner's Manual*

- Muscular endurance** - the ability of a muscle or muscle group to perform repeated contractions against a light load for an extended period of time.
- Obesity** - excess body fat.
- Overload** - to exercise a muscle or muscle group against resistance greater than that which is normally encountered. The resistance (load) can be maximal or near-maximal.
- Potential energy** - energy by virtue of position.
- Power** - work performed per unit time.
- Progressive resistance** - overloading a muscle or muscle group consistently throughout the duration of a weight-resistance program.
- Protein** - a basic foodstuff containing amino acids.
- Reliability** - the extent to which an experiment, test or measuring procedure yields the same results on repeated trials. Also known as reproducibility or repeatability.
- Repetition maximum(RM)** - the maximum load that a muscle or muscle group can lift in a given number of repetitions before fatiguing. For example, an eight-RM load is the maximum load that can be lifted eight times.
- Response** - a sudden temporary adjustment in physiological function brought on by a single exposure to exercise, e.g., the rise in heart rate associated with an exercise bout.
- Set** - in an interval training program, a group of work and relief intervals. In weight lifting, the number of repetitions performed consecutively without resting.
- Slow-twitch fibers** - skeletal muscle fibers characterized by relatively slow contraction times and great capacity for the aerobic production of adenosine triphosphate.
- Static contraction** - a muscular contraction that does not involve changes in the angle of the joint(s) involved.

## *CYBEX Classic Owner's Manual*

- Steady state** - that state of physiological stability wherein the energy demands of the body can be met relatively easily for a prolonged period of time.
- Strength** - the ability to exert muscular force briefly.
- Submaximal exercise** - usually exercise at less than maximal intensity, but may also refer to exercise of less than maximal duration.
- Torque** - the force exerted in rotating an object about an axis of rotation; it is the production of perpendicular force (F) and the length of the lever arm (d):  $T=Fd$ .
- Training** - a program of exercise designed to improve the skills and increase the energy capacities of an athlete for a particular event.
- Validity** - the extent to which a measurement or information is relevant or meaningful; appropriate to the end in view and supported by objective truth.
- Velocity** - the rate at which an objects position changes with time; that is the total change in position divided by the total change in time:  $V=d/t$ .
- Weight** - the weight of an object is the gravitational force exerted on it by the earth.  $W=mg$ , where  $g$  = gravitational acceleration.
- Work** -  $W = Fd$ . The amount of work performed is equivalent to the force applied to an object times the distance the object is moved.





# Single-Set & Circuit Training Diary

MACHINE	Seat Pad	Date																												
		Plates																												
		Reps																												
		Plates																												
		Reps																												
		Plates																												
		Reps																												
		Plates																												
		Reps																												
		Plates																												
		Reps																												
		Plates																												
		Reps																												
		Plates																												
		Reps																												
		Plates																												
		Reps																												
		Plates																												
		Reps																												
		Plates																												
		Reps																												
		Plates																												
		Reps																												
		Plates																												
		Reps																												







Strength training can be a safe and rewarding activity. Always follow the recommendations listed below as they can help ensure training is productive and free from injury.

1. All Training or rehabilitation sessions should be supervised by trained personnel.
2. It is very important that all users be instructed on the proper use of each CYBEX Modular Strength systems. Particular attention should be given to the following:
  - A. Setup and alignment for each individual.
  - B. Entrance and exit from the unit.
  - C. Proper form when using the unit.
3. To reduce chance of injury, users should adhere to the following rules:
  - A. Keep head and limbs clear of cable/pulley junction(s).
  - B. Do not exceed any exercise or movement restrictions prescribed by a doctor or therapist. This is particularly important for those at risk due to:
    - Known heart disease
    - Known hypertension (high blood pressure)
    - Obesity

4. Instruct all users to report any equipment irregularity or personal injury to supervisory personnel immediately.
5. Instruct all personal in equipment inspection and accident recording/reporting.
6. Inspect and maintain equipment at regular intervals. Pay particular attention to cable and hardware inspection as noted in Section 3.
7. Use extra caution when assembling and installing equipment, particularly when lifting or moving heavy objects (i.e. installing weight stacks) and when using power tools.

8. **CAUTION:** *CYBEX recommends anchoring all CYBEX Strength Systems equipment to the floor for maximum safety.*

**NOTE:** *CYBEX is not responsible for the actual anchoring of equipment. Consult with a professional contractor.*

Use fasteners having a minimum of 500 lbs tensile capacity (3/8" grade 2 bolt or better).

*If all legs/frames do not contact surface, DO NOT pull down with anchors. Shim any leg or frame not in contact with surface with flat washers.*

# 4000

## MUSCLES TRAINED

Latissimus Dorsi, Pectoralis, Teres Major/Minor, Abdominals, Anterior/Posterior Deltoids

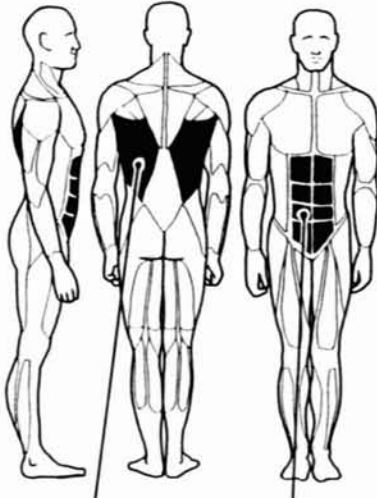

Latissimus Dorsi      Abdominals

The CYBEX Pullover incorporates an adjustable pin system to tailor the range of motion to suit individual users as well as an adjustable seat for precise axis alignment. Entry and exit is made simple through the use of a foot lever advance which is used to bring the pullover arm into the start position after the user is seated. An upholstered seat belt is standard.

## INSTRUCTIONS

1. Adjust seat height so that shoulder joint is aligned with the axis of the cam.
2. Press foot lever advance toward floor to move the Pullover arm to the start position; locate elbows on the pads provided.
3. Set range limiting (if desired) by inserting range of motion pin in position located on righthand side of machine next to cam.
4. Keep a light grip on the bar while pushing down with elbows.
5. Start and end movement with smooth, controlled movements.
6. When finished, depress foot lever advance to return weights and exit the machine.

## PULLOVER

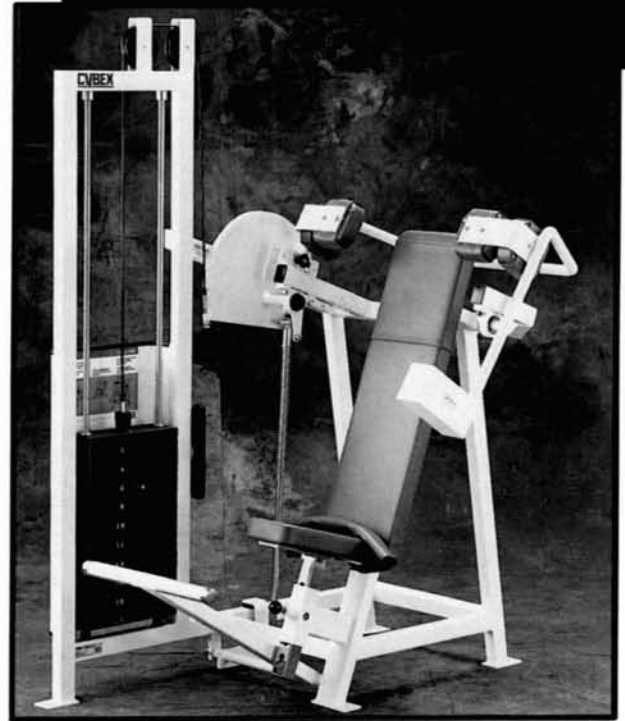

## SPECIFICATIONS:

Machine weight: 535 lbs.  
Weight stack: 250 lbs.  
Dimensions: 38" w x 54"l

Graduated weight stack also available

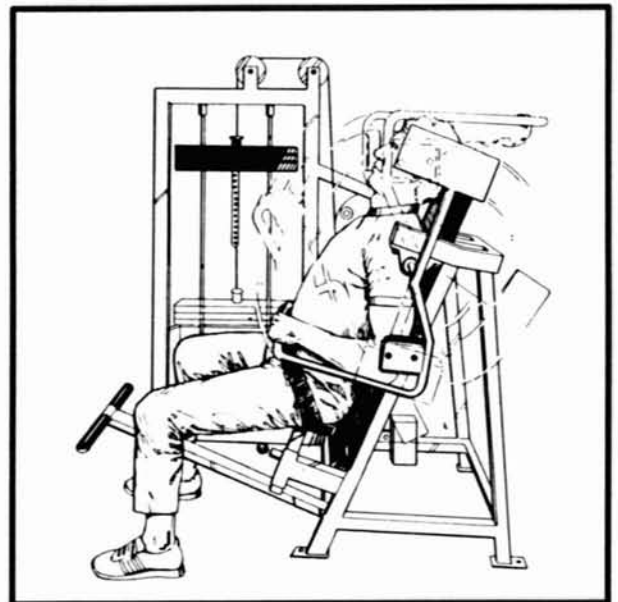



# 4005

## MUSCLES TRAINED

Latissimus Dorsi, Teres Major, Pectoralis group, Rhomboids, Brachialis, Biceps

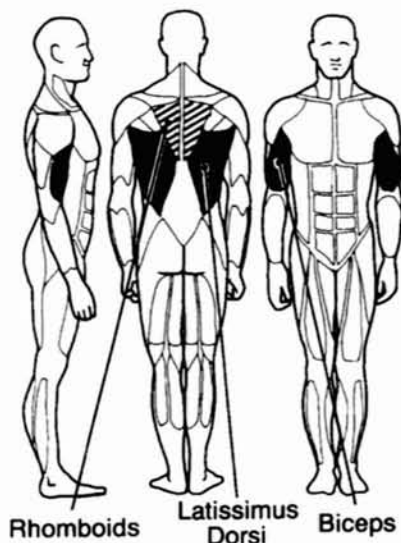

The CYBEX Lat Pulldown features adjustable knee pads for stabilization when training with resistance greater than bodyweight. Wide and narrow grip bars are standard.

## INSTRUCTIONS

1. Adjust the thigh pads to allow access and stabilization while lifting.
2. Check the weight stack to insure appropriate resistance.
3. Grasp the bar at shoulder width and sit down with knees under thigh pads.
4. Lean back slightly at hips and maintain.
5. Pinch shoulder blades down and back.
6. Maintaining shoulder position, bend arm and bring bar down in front of face with elbows alongside body.
7. Smoothly return bar to overhead position while maintaining hip position.
8. If the shoulder blade position changes during return motion, reset before beginning each repetition.

## LAT PULLDOWN

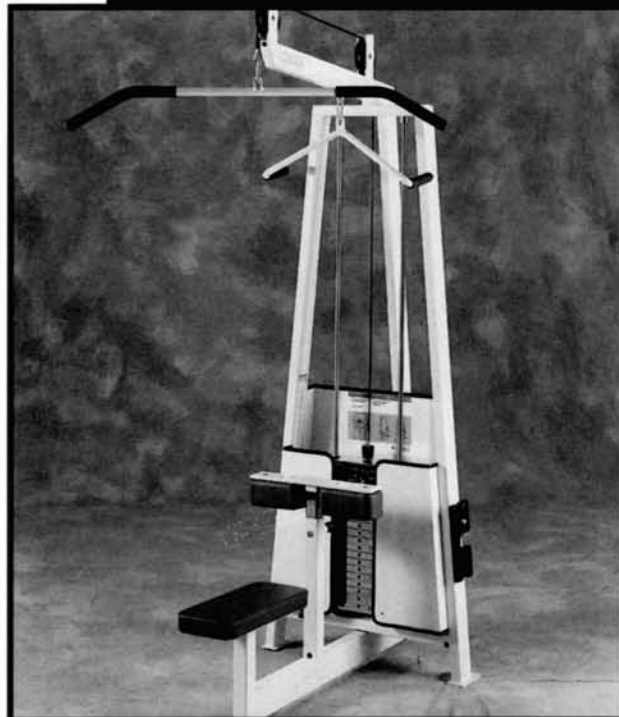

### SPECIFICATIONS:

Machine weight: 450 lbs.  
Weight Stack: 250 lbs.  
Dimensions: 32" w x 55" l

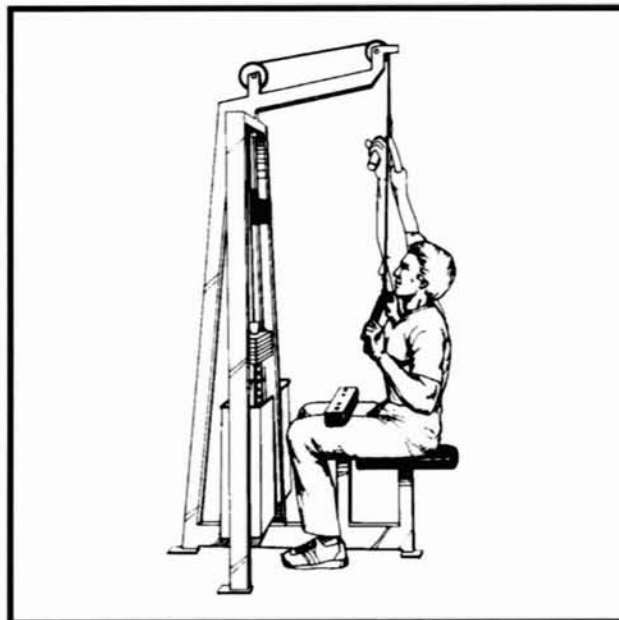

**MUSCLES TRAINED**

Latissimus Dorsi, Deltoids, Teres Major/Minor, Infraspinatus, Rhomboids, Trapezius, Biceps

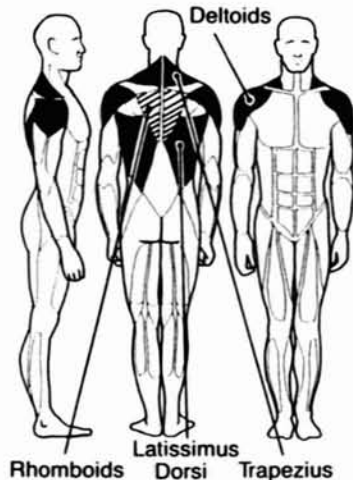

The CYBEX Rowing machine includes a contoured sternum pad to reduce lower back involvement and to promote upper back muscle isolation without interfering with natural arm motion. This pad adjusts to provide maximum support and proper positioning for any arm length. The overhead pivot guides the user through a natural arc of motion and allows the wrists to remain in a neutral position throughout the complete range of motion.

**INSTRUCTIONS**

1. Adjust seat height so that arms are approximately parallel with the floor when grasping the handles. Some individuals prefer a seat height one setting higher when using neutral grips.

*NOTE: Use of barbell grips emphasizes rear deltoid, trapezius and rhomboid training; neutral grips emphasize latissimus dorsi recruitment.*

2. Adjust sternum pad so that the arms can fully straighten when the handles are in the start position.
3. Maintain contact with seat and sternum pad at all times.
4. Select neutral or barbell grip.
5. Pull handles toward body with a smooth, controlled motion.
6. Slowly return handles to start position.

**ROWING****SPECIFICATIONS:**

Machine Weight: 435 lbs.  
 Weight Stack: 250 lbs.  
 Dimensions: 34" w x 60" l

Graduated weight stack also available.

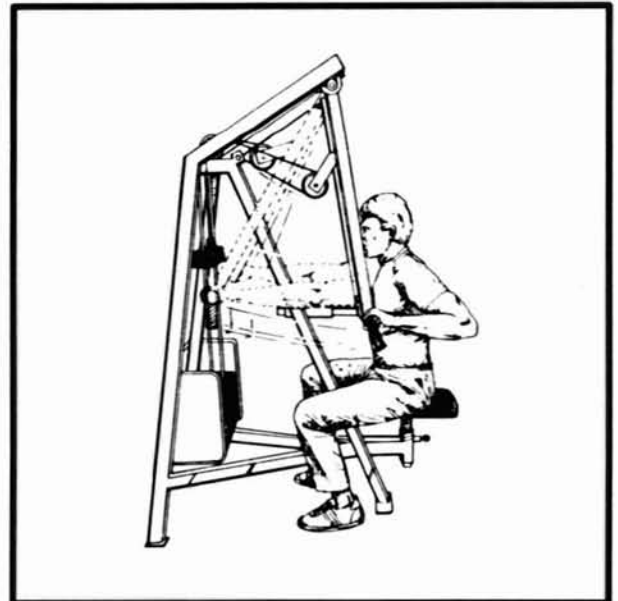

**MUSCLES TRAINED**

Pectoralis group, Anterior Deltoids, Coracobrachialis, Serratus Anterior, Triceps

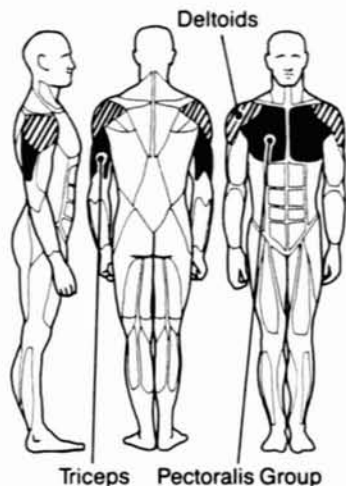

The CYBEX Chest Press offers a choice of neutral or barbell grips, properly angled to prevent inappropriate joint stress and enhance comfort and lifting ability. The foot lever advance allows the user to control start position and facilitates easy entry and exit.

**INSTRUCTIONS**

1. Adjust seat height so that handles are approximately even with the sternum.
2. Push foot lever advance toward the floor to advance handles to a comfortable start position.
3. Select neutral or barbell grip.
4. Slowly release foot lever advance and place feet on foot platform or floor.
5. Start movement by pressing the handles forward with a smooth, continuous motion. **DO NOT LOCK OUT ELBOWS** at finish position.
6. Slowly return to the start position.
7. When finished, depress the foot lever advance, release the handles, and gently lower the weight by returning the foot lever advance to its start positions

**CHEST PRESS****SPECIFICATIONS:**

Machine weight: 510 lbs.  
 Weight stack: 250 lbs.  
 Dimensions: 45" w x 55" l

Graduated weight stack also available.

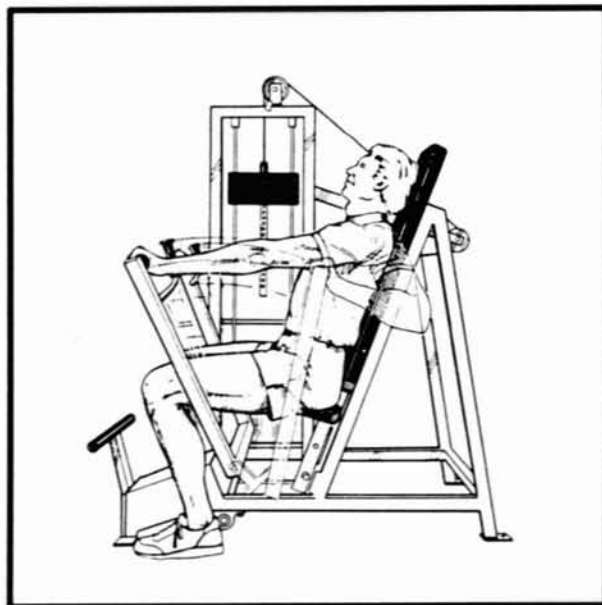

4022

FLY

**MUSCLES TRAINED**

Pectoralis group

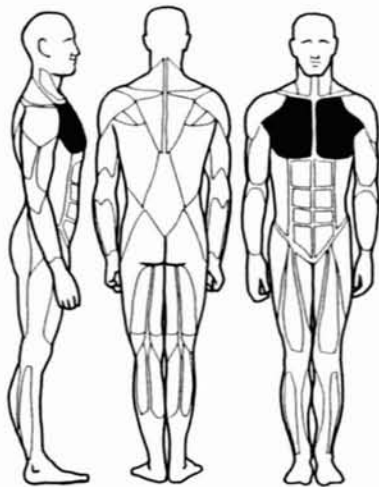

Pectoralis Group

The CYBEX Fly incorporates underseat cams for easy entry and exit and an axis of rotation parallel to the seat back so that axis alignment remains correct at any seat height. Dual hand grips accommodate any forearm length and allow for a properly extended arm position; optional extended pads are also available (Product # 4022K140). A foot lever advance allows the user to determine the desired start position and range of motion while helping to prevent inappropriate joint stress.

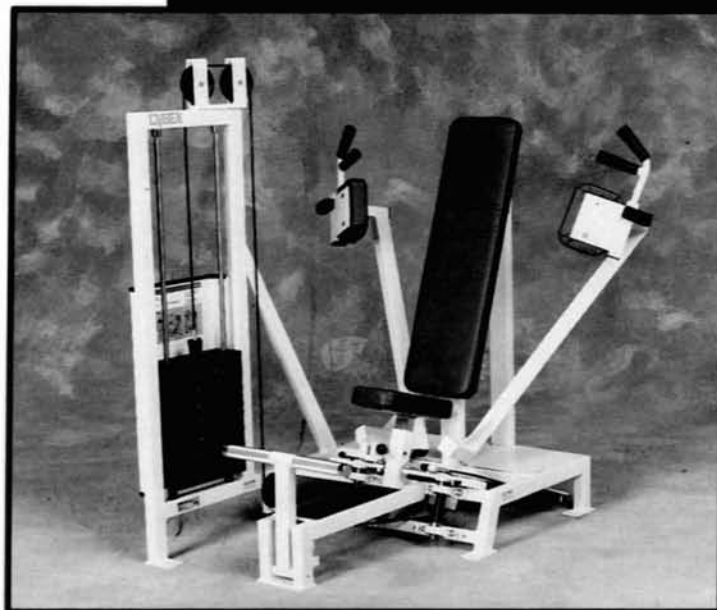
**SPECIFICATIONS:**

Machine weight: 510 lbs.  
 Weight stack: 170 lbs.  
 Dimensions: 53" w x 49" l

A graduated weight stack is standard; a non-graduated stack is also available

**INSTRUCTIONS**

1. Adjust seat height so that elbows are slightly below shoulders when grasping handles.
2. Press foot lever advance to bring arms to a comfortable start position.
3. Locate forearms on pads and lightly grip handles; release foot lever advance.
4. Lead with elbows so that they meet in front of chest.
5. Slowly return to start position with a smooth, continuous motion.
6. When finished, press the foot lever advance, release the handles and gently return weights to the start position.

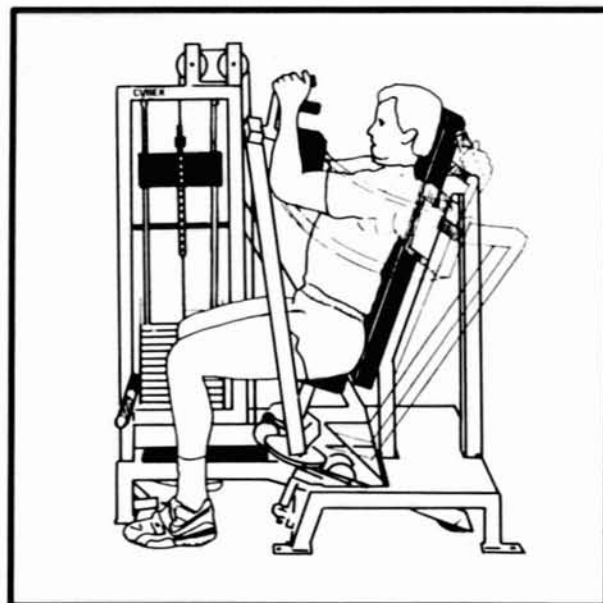

4025

## MUSCLES TRAINED

Deltoids, Supraspinatus, Serratus Anterior, Upper Trapezius, Subscapularis, Triceps

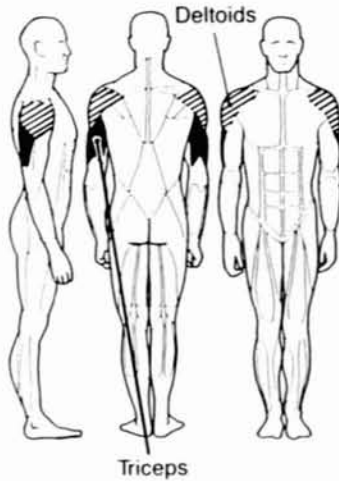

The CYBEX Shoulder Press has dual hand grips and a counterbalanced input arm to allow even inexperienced or deconditioned exercisers to develop overhead lifting strength. An adjustable seat height ensures optimal positioning and range of motion control.

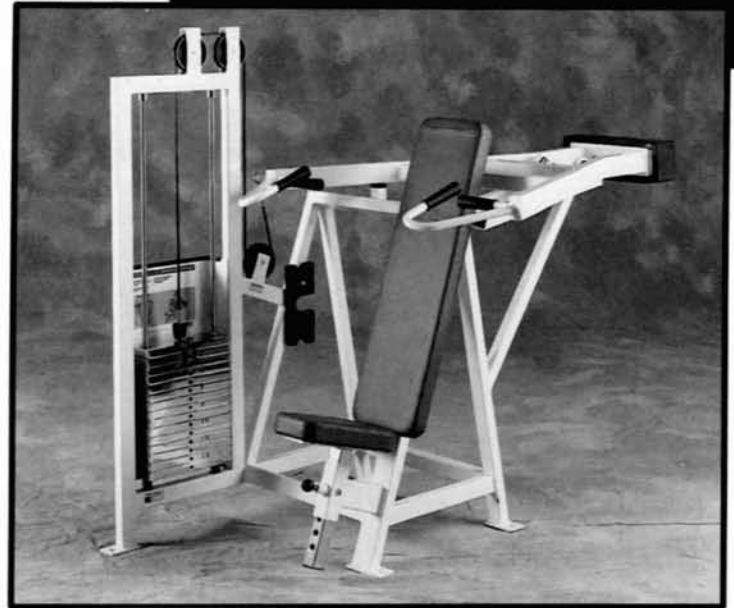

## SPECIFICATIONS:

Machine weight: 440 lbs.  
Weight stack: 187.5 lbs.  
Dimensions: 46" w x 64" l

Graduated weight stack also available.

## INSTRUCTIONS

1. Adjust seat height so that handles are level with tops of shoulders.

*NOTE: To reduce range of motion, lower seat height one position.*

2. Select neutral or barbell grips.

*NOTE: Neutral grip position increases anterior deltoid recruitment.*

3. Start movement by pressing upward with a smooth, continuous motion.
4. Slowly return weights to start positions.

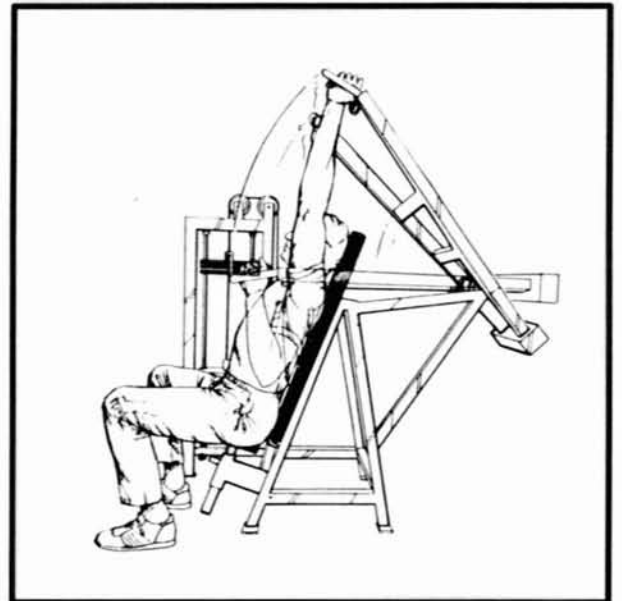

**MUSCLES TRAINED**

Trapezius, Deltoid

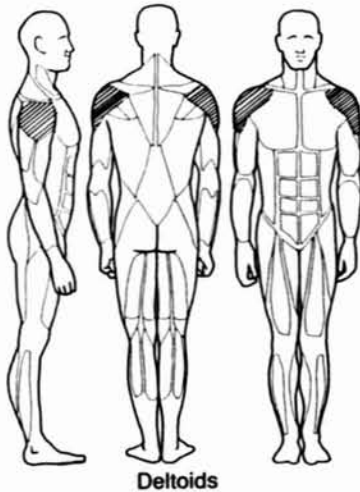

The CYBEX Lateral Raise is designed with a slight forward angle to enhance stability and isolation by utilizing the effect of the user's bodyweight. The exercise arms are counterbalanced to reduce the starting resistance and the grips swivel automatically to accommodate forearm lengths for maximum comfort

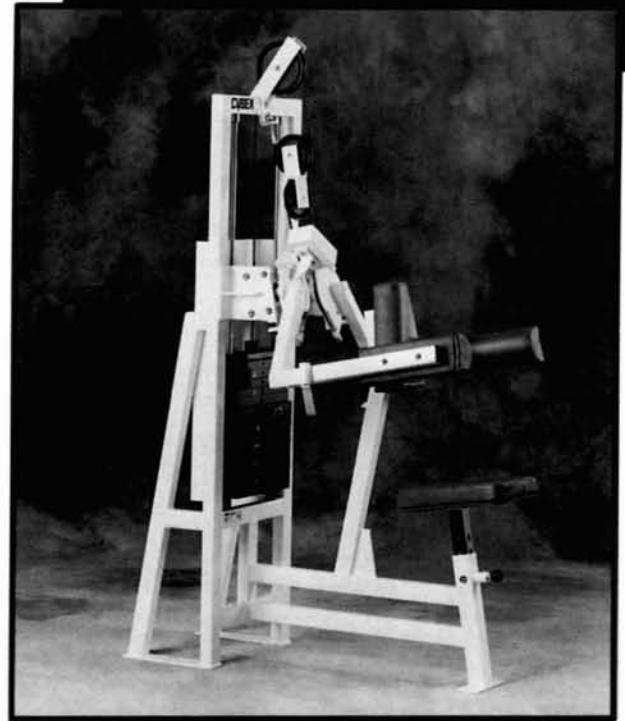
**LATERAL RAISE****SPECIFICATIONS:**

Machine weight: 380 lbs.  
 Weight stack: 187.5 lbs.  
 Dimensions: 27" w x 46" l

Graduated weight stack also available.

**INSTRUCTIONS**

1. Adjust seat height so that the shoulders align with the axis of the cams.

**NOTE:** Pads should remain in consistent contact with arm during use; if pad slides up, adjust seat height one position higher. If pad slides down, adjust seat height one position lower.

2. Maintain contact with the chest pad.
3. Grip handles lightly and push elbows out with a smooth, continuous motion until elbows are at shoulder height.
4. Slowly return to the start position.



4035

## MUSCLES TRAINED

Triceps, Flexor/Extensor Carpi Ulnaris

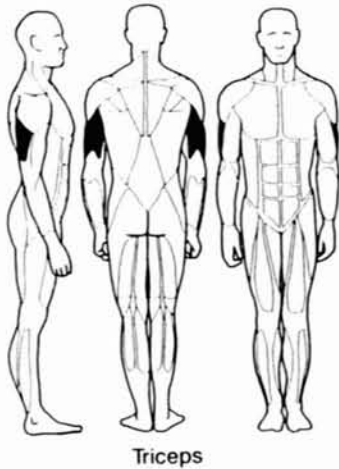

The CYBEX Tricep Extension features an adjustable seat and backpad to accommodate virtually any torso length and to provide correct axis alignment. The handle design automatically adjusts for any forearm length to provide optimum triceps isolation.

## INSTRUCTIONS

1. Adjust seat height so that upper arm is parallel to the floor.
2. Adjust backpad so that elbows are positioned on the center of the pad.
3. Grip handles lightly.
4. Start movement by straightening arms while maintaining contact with the upper arm on the elbow pad.
5. Slowly return to starting position with a smooth, controlled motion.

## TRICEP EXTENSION

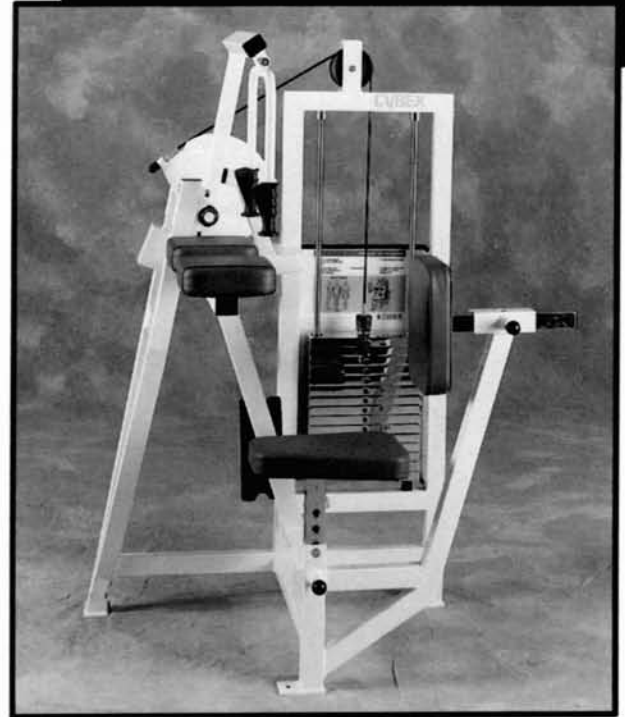

### SPECIFICATIONS:

Machine weight: 395 lbs.  
Weight stack: 187.5 lbs.  
Dimensions: 35" w x 42" l

Graduated weight stack also available.

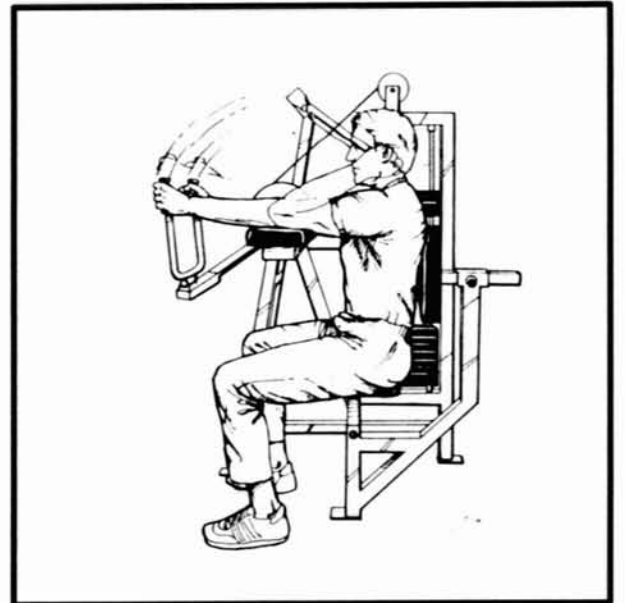

# 4040

## MUSCLES TRAINED

Biceps, Brachialis, Brachioradialis

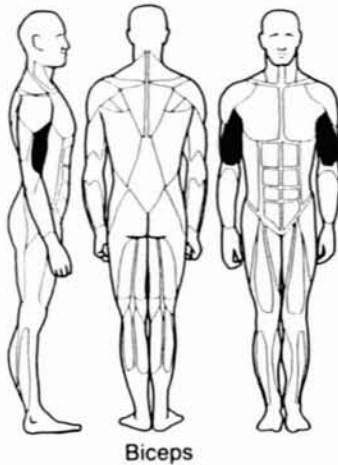

The CYBEX Arm Curl encourages correct alignment, proper form and easy reproduceability from session to session by providing engraved, numerically indexed adjustments for both the chest pad and seat height. In addition, the handles pivot to automatically accommodate any forearm length.

## INSTRUCTIONS

1. Adjust seat height so that upper arm is parallel to the floor.
2. Adjust chest pad so that the elbows are positioned in the center of the pad.
3. Grip handles lightly with palms up.
4. Start movement by bending elbows, bringing hands toward forehead.
5. Slowly return the weights to the start position with a smooth, controlled movement.

## ARM CURL

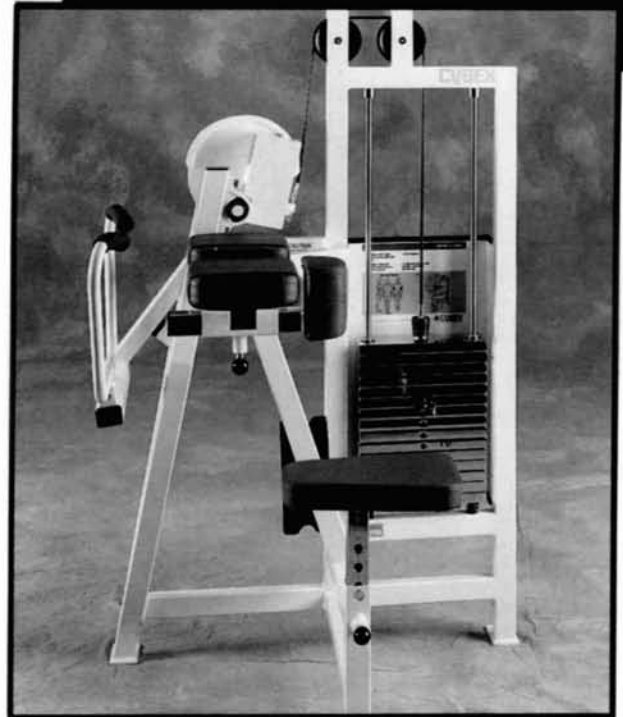

### SPECIFICATIONS:

Machine weight: 380 lbs.  
Weight stack: 187.5 lbs.  
Dimensions: 35" w x 40" l

Graduated weight stack also available

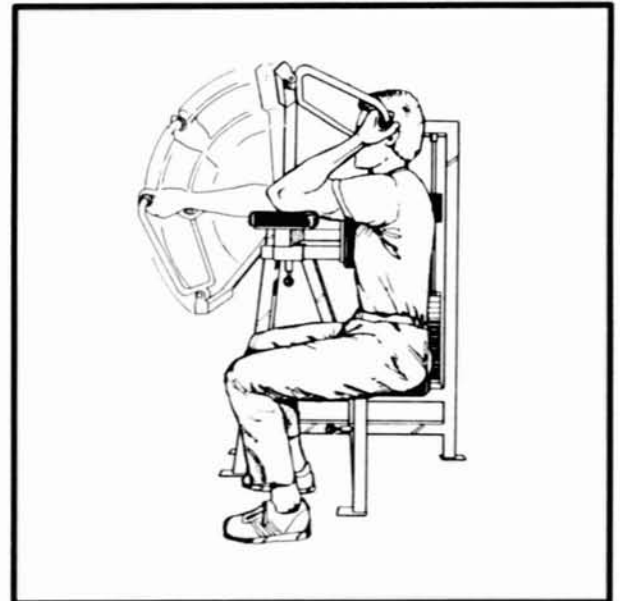



# 4055

## MUSCLES TRAINED

Triceps, Pectoralis group, Latissimus Dorsi, Deltoids

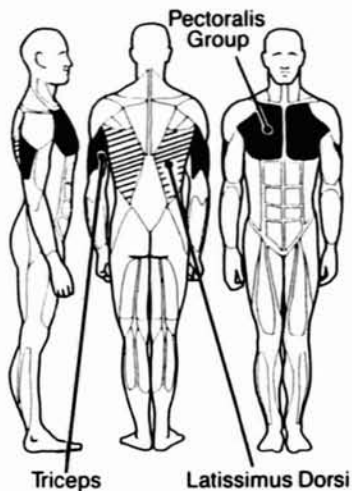

The CYBEX Tricep Press allows users to simulate bodyweight dips with resistance in small increments. Handgrips adjust in width for any size user, and a seat-belt is included for training with heavier-than-bodyweight resistance.

## INSTRUCTIONS

1. Adjust seat height to yield desired range of motion.
2. Select wide or narrow grip position by rotating handles in or out. Select the narrowest position which clears hips.
3. Fasten seat belt if desired.
4. Start movement by pressing handles downward with a smooth, controlled motion.
5. Slowly return weight to starting position.

## TRICEP PRESS

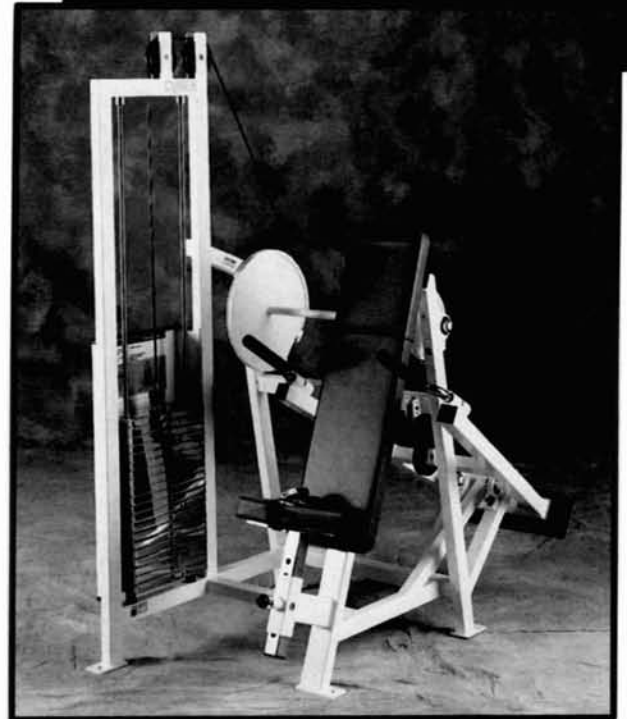

### SPECIFICATIONS:

Machine weight: 540 lbs.  
Weight stack: 250 lbs.  
Dimensions: 38" w x 53" l

Graduated weight stack also available.

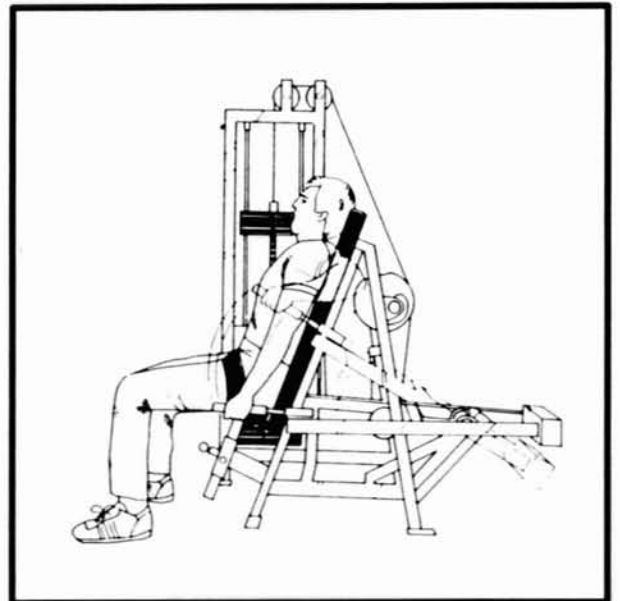

**MUSCLES TRAINED**

Pectoralis group, Deltoids, Serratus Anterior, Triceps

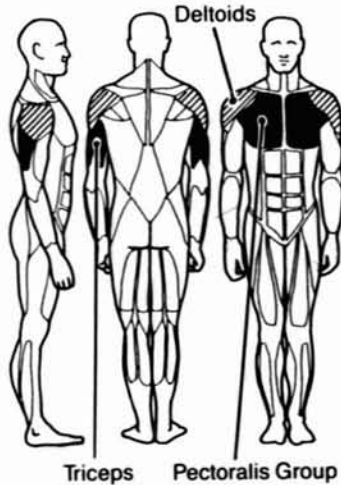

The CYBEX Incline Press utilizes an unconventional angle to reduce the machine footprint and to offer easy ingress and egress as well as a comfortable upright orientation. Both neutral and barbell grips are provided for comfort and training variability. A convenient foot lever advance and non-skid foot platform are also included for user safety and convenience.

**SPECIFICATIONS:**

Machine weight: 535 lbs.  
 Weight stack: 250 lbs.  
 Dimensions: 47" w x 64" l

Graduated weight stack also available.

**INSTRUCTIONS**

1. Adjust seat height so that barbell grips are even with chest.

*NOTE: Raising the seat height above this level will emphasize the training effect on the pectoralis group, while decreasing the emphasis on the anterior deltoid muscles. Lowering the seat height below this level will increase emphasis on the anterior deltoids.*

2. Press the foot lever advance to move handles forward.
3. Select neutral or barbell grips.
4. Slowly release foot lever advance and place feet on foot platform or floor.
5. Start movement by pressing the handles forward with a smooth, continuous motion.
6. Slowly return to the start position.
7. When finished, use foot lever advance to return weights, and exit the machine.

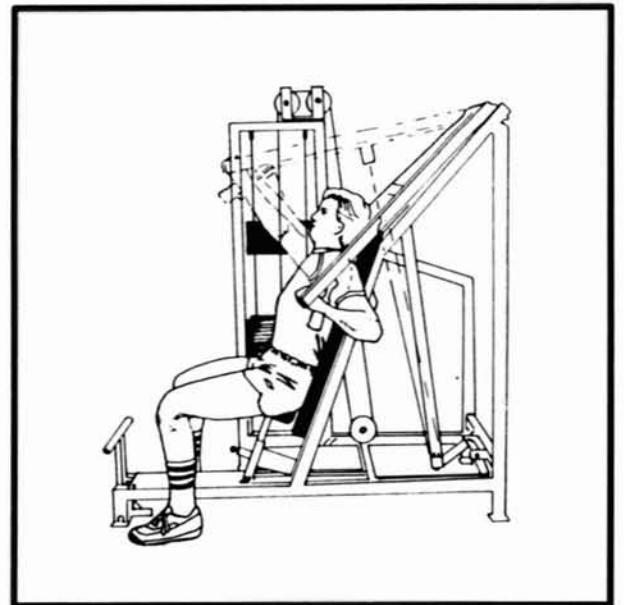

# 4105, 4108 with RLD

## MUSCLES TRAINED

Quadriceps, Rectus Femoris

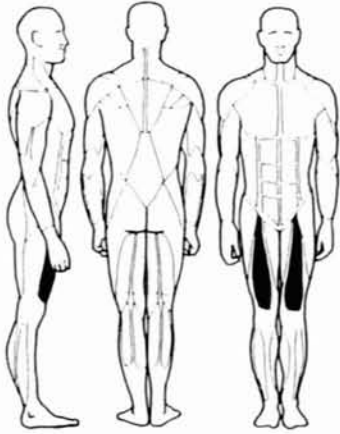

Quadriceps

The CYBEX Leg Extension is designed to provide correct, consistent alignment with the knee axis of rotation for maximum safety and effectiveness. The unit also features an offset input arm which allows the pad to adjust for tibia length without affecting the start position of the knee. A contoured seat pad facilitates easy entry and exit and enhances stability without limiting available range of motion.

## INSTRUCTIONS

1. Adjust shin pad so that pad rests just above the ankle.
2. Adjust backpad so that knees align with machine axis of rotation; area behind knees should lightly contact the edge of the seat pad.
3. Start movement by slowly extending legs with a smooth, controlled motion.
4. Slowly return to start position.

## LEG EXTENSION

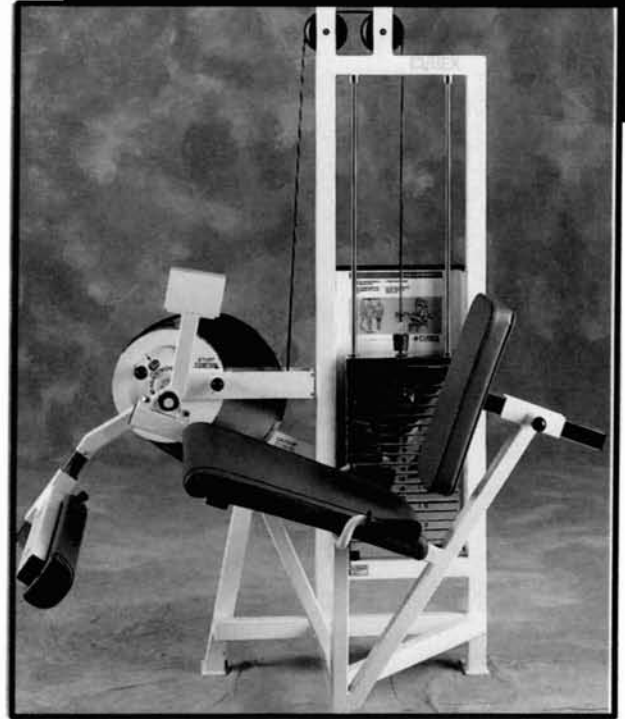

### SPECIFICATIONS:

Machine weight: 500 lbs.  
Weight stack: 250 lbs.  
Dimensions: 36" w x 43" l

Graduated weight stack also available.



# 4110, 4113 with RLD

## MUSCLES TRAINED

Hamstrings, Gastrocnemius, Sartorius/Gracilis

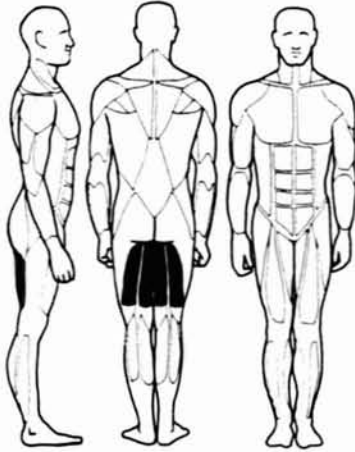

Hamstrings

The CYBEX Leg Curl incorporates a divergent angle between hip and chest pads to minimize the possibility of back hyperextension and to allow the user to lift more weight than would be possible on a traditional flat bench. In addition, the chest pad is contoured to encourage the user's hands to fall naturally to the grips for maximum stability.

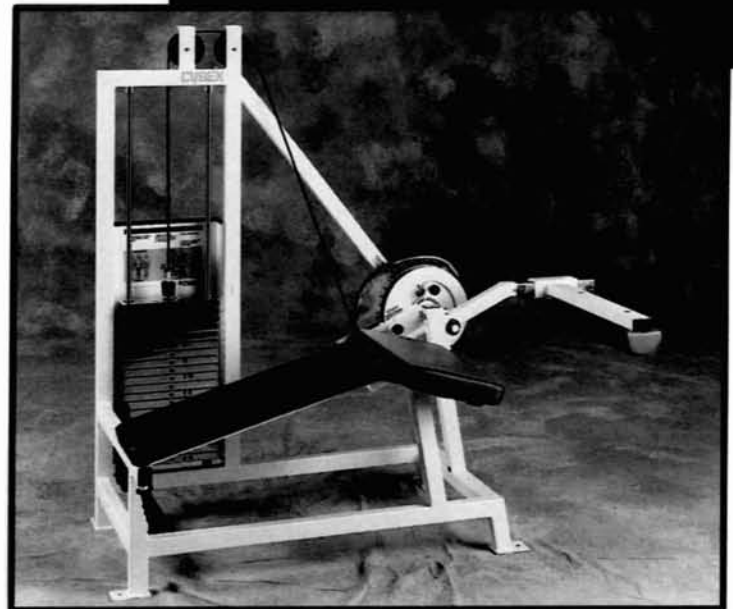

## LEG CURL

### SPECIFICATIONS:

Machine weight: 485 Lbs.  
Weight stack: 250 Lbs.  
Dimensions: 36" w x 64" l

Graduated weight stack also available.

## INSTRUCTIONS

1. Adjust the leg pad so that pad is positioned just above the Achilles tendon.
2. Adjust body position on bench so that knees are located off the bench and are aligned with the machines axis of rotation.
3. Start movement by curling heels to buttocks with a smooth, controlled motion.
4. Slowly return to start position.

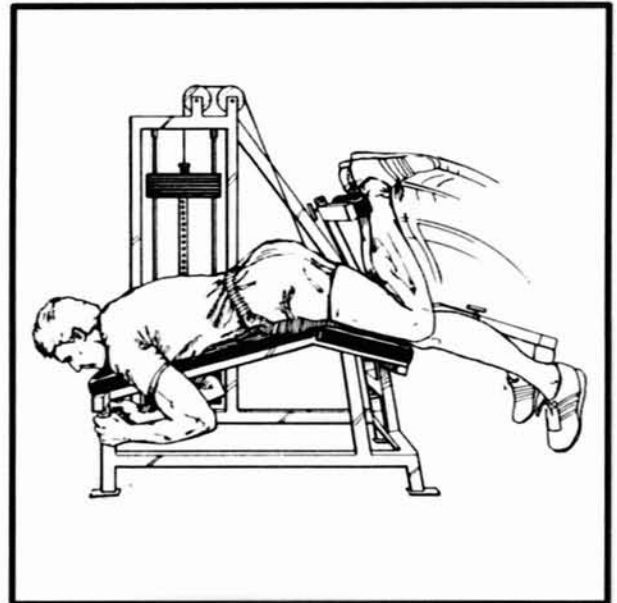

# 4117

## MUSCLES TRAINED

Gastrocnemius, Soleus, Plantaris

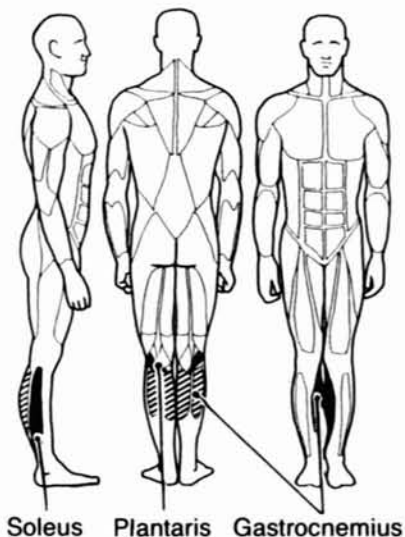

The CYBEX Standing Calf Raise offers dual foot plates and an adjustable input arm to accommodate users of any height in the correct exercise position. This unit also offers a 1:1 lifting ratio and an optional free weight kit which allows the addition of Olympic plates for resistance above the 300 pounds on the weight stack (Product # 4117K052.)

## INSTRUCTIONS

1. Select the footplate which allows the shoulder pads to be as close to parallel with the ground as possible.

*NOTE: Individuals 5'2" or under generally use upper footplate.*

2. Adjust the shoulder pads so that the weight plates selected are in a slightly raised position when heels are in full dorsi flexion. Maintain correct posture: Chin in, shoulders back, chest high, knees over toes, hips tucked in.
3. Start movement by elevating heels as far up as possible with a smooth, continuous motion.
4. Slowly return to the starting position by lowering heels.

## STANDING CALF RAISE

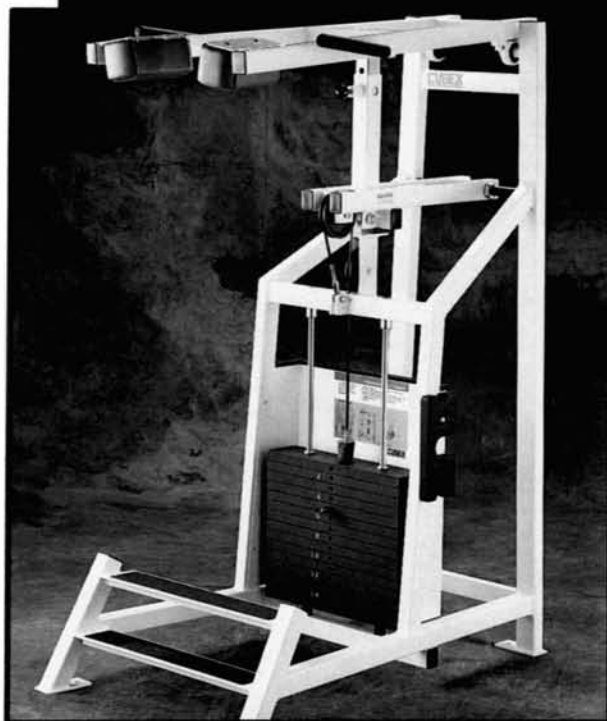

### SPECIFICATIONS:

Machine weight: 365 lbs.  
Weight stack: 300 lbs.  
Dimensions: 47" w x 30" l

Graduated weight stack also available.

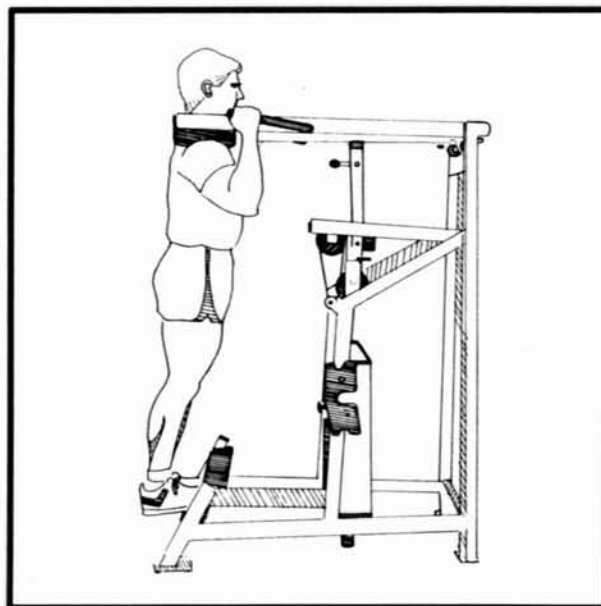

**MUSCLES TRAINED**

Iliopsoas, Rectus Femoris, Pectineus, Gluteal group, Hamstrings, Adductor Magnus, Longus, Brevis, Gracilis, Gluteus Medius, Minimus, Maximus, Tensor Fasciae, Sartorius

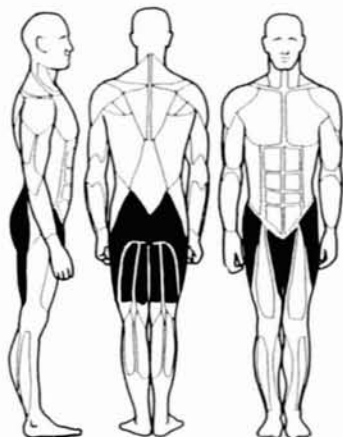

Hip Flexors, Hip Extensors,  
Hip Adductors, Hip Abductors.

The CYBEX Multi Hip provides a comfortable and functional standing position for hip flexion/extension and abduction/adduction in one space-efficient format. An adjustable foot platform facilitates correct axis alignment regardless of hip height. The start position is adjustable in 15° increments to accommodate the different exercises and individual ranges of motion.

**INSTRUCTIONS**

1. Adjust platform height so that hip joint aligns with the axis of the pivot arm.
2. Adjust position of the leg pad so that the pad contact is just above the knee.
3. Select exercise. The reference chart on the following page indicates the correct procedures for each movement.
4. Align the involved joint with the axis of the pivot arm and grasp handles for stabilization.
5. Start and end movement with smooth, controlled motions.

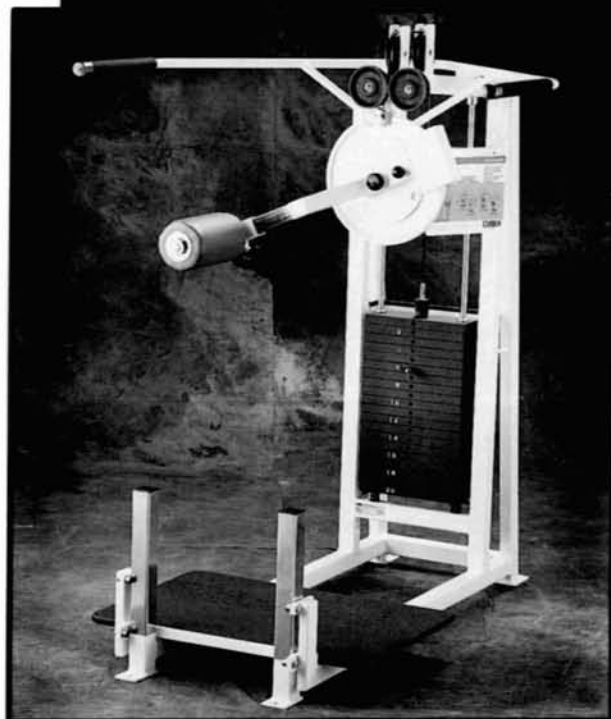
**MULTI HIP****SPECIFICATIONS:**

Machine weight: 510 lbs.  
Weight stack: 250 lbs.  
Dimensions: 28" w x 58" l

Graduated weight stack also available.

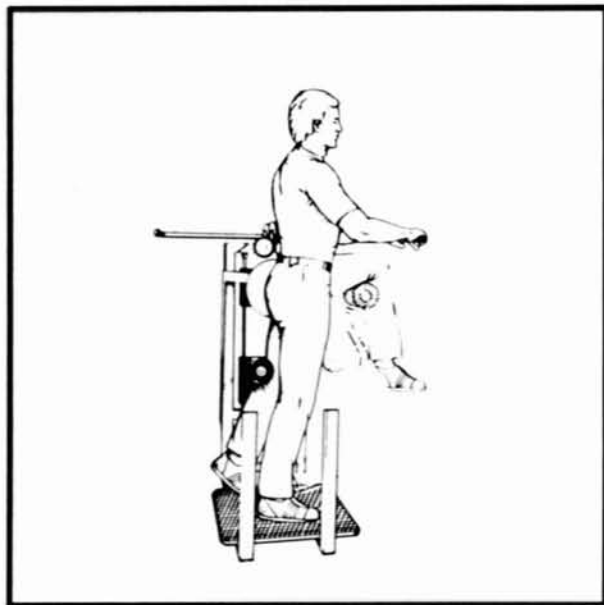

## HIP FLEXION

- A. For **RIGHT HIP FLEXION**: Position the leg pad between 4 and 6 o'clock.

For **LEFT HIP FLEXION**: Position the leg pad between 6 and 8 o'clock.

- B. Stand as indicated in Fig. 1 with the side to be exercised closest to the pivot arm. Align the hip with the axis of the pivot arm and grasp handles for stabilization. The leg pad should be positioned comfortably across the front of the leg, just above the knee.
- C. Lift the leg bar to complete forward flexion and lower to extension with smooth, controlled motions.



Figure 1

## HIP EXTENSION

- A. For **RIGHT HIP EXTENSION**: Position the leg pad between 7 and 9 o'clock.

For **LEFT HIP EXTENSION**: Position the leg pad between 3 and 5 o'clock.

- B. Stand as indicated in Fig. 2 with the side to be exercised closest to the pivot arm. Align the hip with the axis of the pivot arm and grasp handles for stabilization. The leg pad should be positioned comfortably across the back of the leg, just above the knee.
- C. Lift the leg bar to complete backward extension and lower to flexion with smooth, controlled motions.

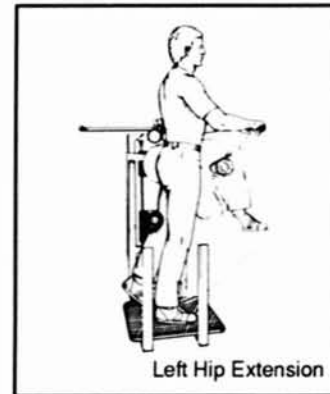

Figure 2

## HIP ADDUCTION

- A. For **RIGHT HIP ADDUCTION**: Position the leg pad between 3 and 5 o'clock.

For **LEFT HIP ADDUCTION**: Position the leg pad between 7 and 9 o'clock.

- B. Stand as indicated in Fig. 3 with the side to be exercised aligned with the axis of pivot arm. Grasp handles for stabilization. The leg pad should be positioned comfortably across the inside of the leg, just above the knee.
- C. Lift the leg bar across the standing leg to complete adduction and lower to the start position with smooth, controlled motions.



Figure 3

## HIP ABDUCTION

- A. For **RIGHT HIP ABDUCTION**: Position the leg pad between 6 and 8 o'clock.

For **LEFT HIP ABDUCTION**: Position the leg pad between 4 and 6 o'clock.

- B. Stand as indicated in Fig. 4 with the side to be exercised aligned with the axis of pivot arm. Grasp handles for stabilization. The leg pad should be positioned comfortably across the outside of the leg, just above the knee.
- C. Lift the leg bar away from the standing leg to complete abduction and lower to the start position with smooth, controlled motions.

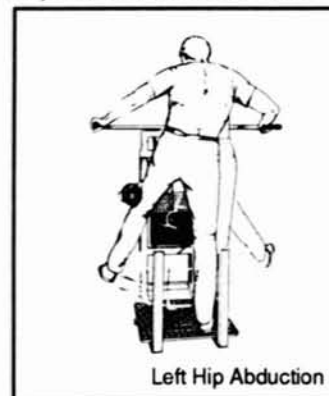
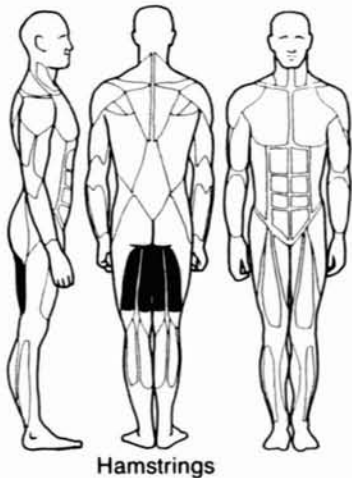

Figure 4

**MUSCLES TRAINED**

Hamstrings



The CYBEX Seated Leg Curl makes hamstring exercise more accessible to special populations such as obese and pregnant individuals, and offers a comfortable alternative to the traditional prone format used for hamstring training. The Seated Leg Curl incorporates an infinitely adjustable thigh stabilization pad which locks in the up position to facilitate easy entry and exit, and a range of motion device to tailor the range of motion desired in 10° increments. An adjustable backpad assures correct axis alignment.

**INSTRUCTIONS**

1. Adjust backpad so that knee is aligned with machine axis (at top of input arm.)
2. Select desired resistance.
3. If range limiting is desired, use body weight to move exercise arm to start position and insert pullbutton in range of motion device on right hand side of machine next to cam.
4. Adjust ankle pad so that the back of ankles rest comfortably on pad, just above the ankle joint.
5. Release pullbutton and drop thigh stabilization pad so that it is snugly against thigh; tighten lock-nob to secure.
6. Start movement by curling heels back toward buttocks.
7. Slowly return to start position with a smooth, continuous motion.
8. To exit, loosen locknob and raise thigh stabilization pad until pullbutton engages.

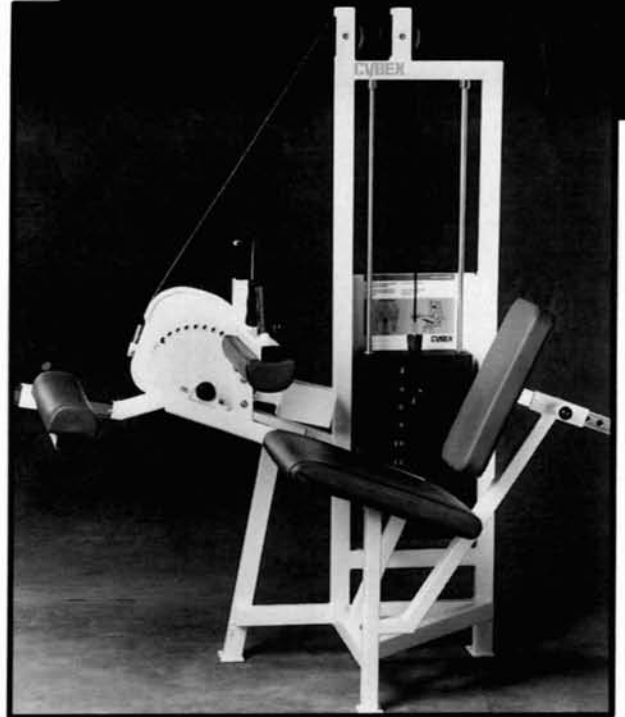
**SEATED LEG CURL****SPECIFICATIONS:**

Machine weight: 530 lbs.  
 Weight stack: 250 lbs.  
 Dimensions: 34" w x 64" l

Graduated weight stack also available.

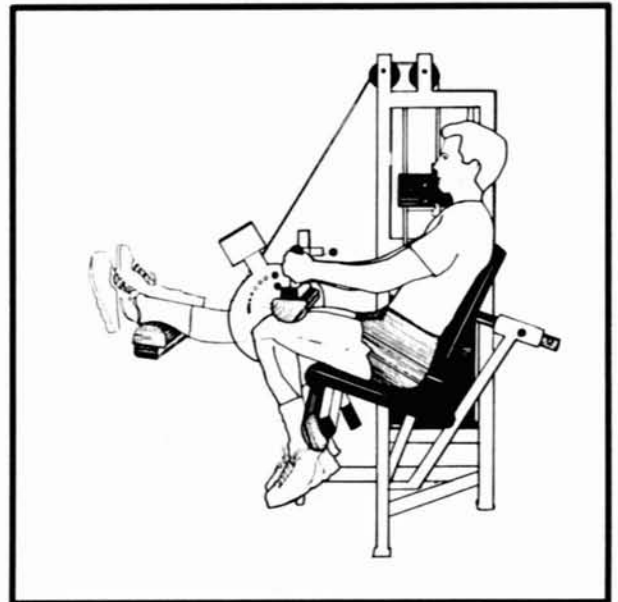

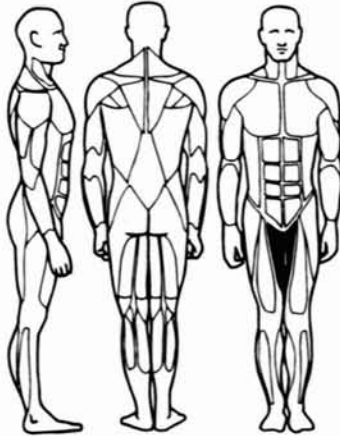

**MUSCLES TRAINED**

The CYBEX Hip Adduction machine utilizes a front mounted weight stack that allows easy accessibility during exercise and conditioning of the inner thigh muscles, and also acts as a privacy shield. The unit employs an upright exercise position to facilitate easy entry and exit, which helps ensure both a comfortable and safe exercise experience and increases peripheral awareness while working-out.

The dual foot pegs are located to maintain a comfortable bent knee position throughout exercise. By placing the leg pad above the knee and eliminating the ankle pad the force generated at the hip is transferred to the machine without the potential of torque being transmitted through the knee.

**INSTRUCTIONS**

1. Sit in machine and adjust range of motion by moving knee pads to desired start position.
2. Grip handles tightly.
3. Lift/lower weights with smooth controlled movements.
4. Exit machine by returning weights to resting position and release knee pads by pulling the release handle that is located on your right.

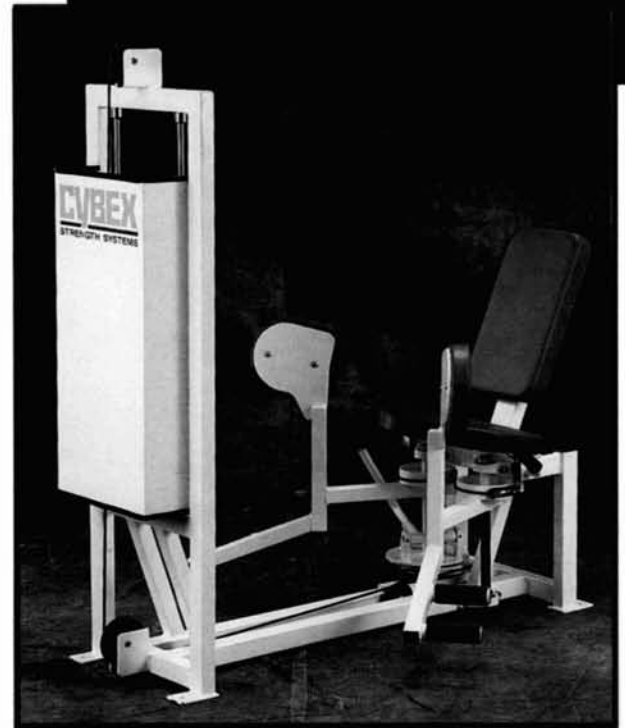
**HIP ADDUCTION****SPECIFICATIONS:**

Machine weight: 530  
 Weight stack: 250  
 Dimensions: 23"w x 54"l

Graduated weight stack also available.

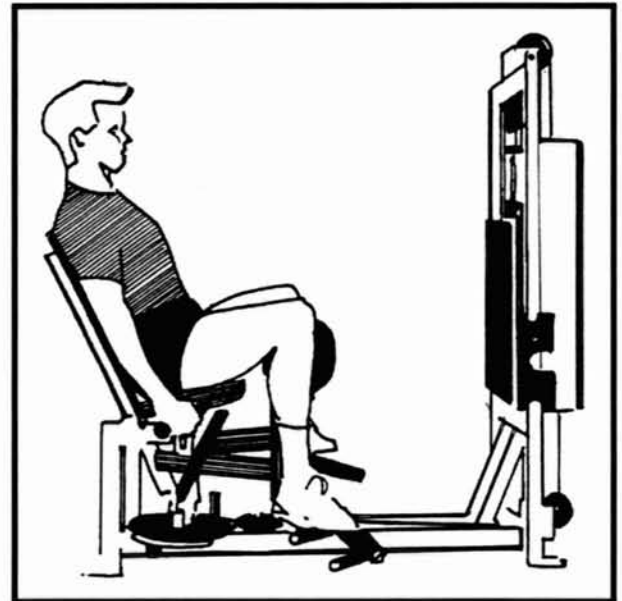

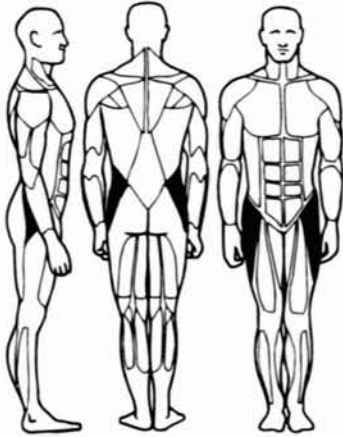
**MUSCLES TRAINED**

The CYBEX Hip Abduction machine utilizes a front mounted weight stack that allows easy accessibility during exercise and conditioning of the outer thigh muscles, and also acts as a privacy shield. The unit employs an upright exercise position to facilitate easy entry and exit, which helps ensure both a comfortable and safe exercise experience and increases peripheral awareness while working-out.

The dual foot pegs are located to maintain a comfortable bent knee position throughout exercise. By placing the leg pad above the knee and eliminating the ankle pad the force generated at the hip is transferred to the machine without the potential of torque being transmitted through the knee.

**INSTRUCTIONS**

1. Sit in machine and adjust range of motion by moving knee pads to desired start position.
2. Grip handles tightly.
3. Lift/lower weights with smooth controlled movements.
4. Exit machine by returning weights to resting position and release knee pads by pulling the release handle that is located on your right.

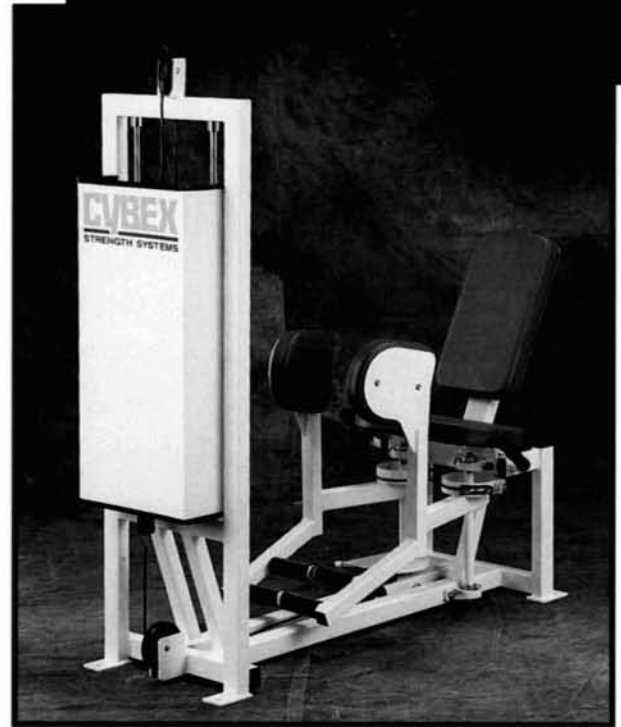
**HIP ABDUCTION****SPECIFICATIONS:**

Machine weight: 470  
 Weight stack: 187.5  
 Dimensions: 23" w x 54" l

Graduated weight stack also available.



# 4201

## MUSCLES TRAINED

Internal and External Obliques, Deep Posterior Rotators, Longissimus, Iliocostalis.

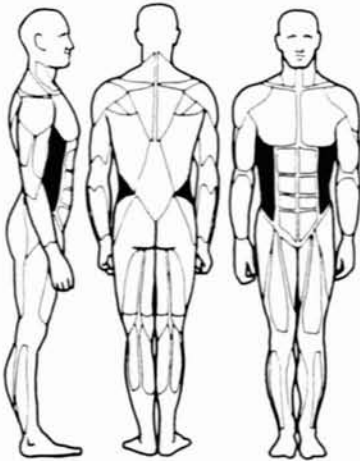

Internal and External Obliques

The CYBEX Rotary Torso offers an effective combination of upper and lower body stabilization to fully isolate torso muscles and to promote proper axis alignment. Shoulder pads and hand grips guide the upper body to a correct, reproducible exercise position, while angled adductor pads and multiple foot position supports secure the lower body.

## INSTRUCTIONS

1. Adjust seat height so that upper pads are positioned across shoulders.
2. Place legs securely against the adductor pads and select a comfortable foot position.
3. Release upper pullbutton and move exercise arm to desired start position. The start position is adjustable in 15° increments.
4. Maintain contact with chest pad and grasp handles.
5. Rotate torso slowly through the desired range of motion.
6. Slowly return to the start position with a smooth, controlled motion.
7. Move pullbutton to start position on opposite side, and repeat the exercise for other side of torso.

## ROTARY TORSO

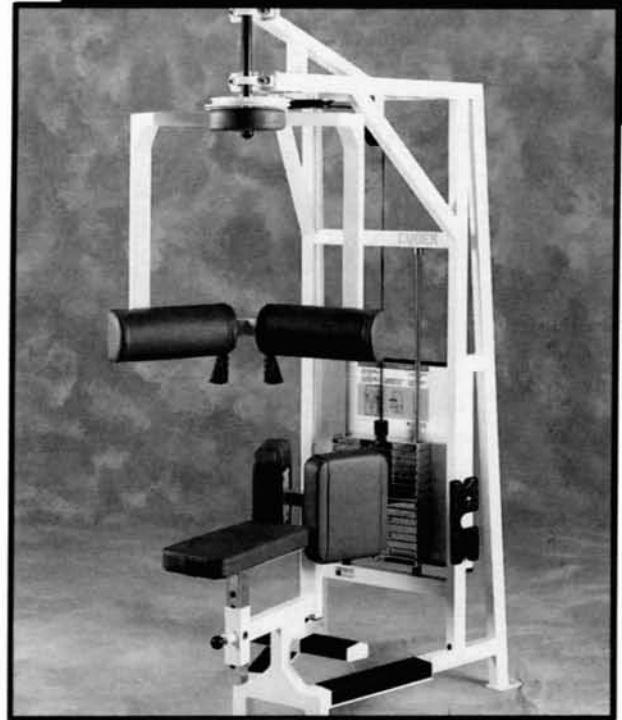

### SPECIFICATIONS:

Machine weight: 545 lbs.  
Weight stack: 187.5 lbs.  
Dimensions: 31" w x 53" l

Graduated weight stack also available

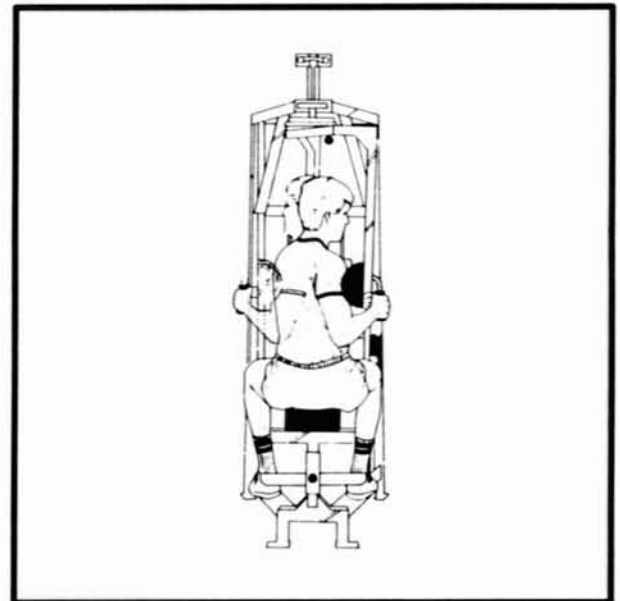

# 4205, 4208 with RLD

## MUSCLES TRAINED

Erector Spinae, Gluteal group

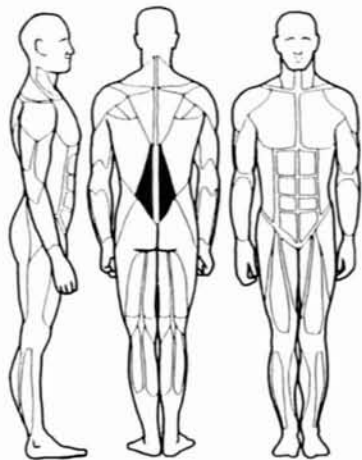

Erector Spinae

The CYBEX Back Extension was designed to take the guesswork out of lower back exercise. Machine-defined knee flexion allows the user to consistently reproduce correct axis alignment by merely selecting a consistent footplate adjustment. A padded seat belt is included for additional stability.

## INSTRUCTIONS

1. Adjust foot plate so that hip is aligned with axis of machine, knees slightly bent.

*NOTE: Maintain contact between upper leg and seat pad.*

2. Fasten seat belt with resistance set at one plate, then rotate to upright position and tighten belt to fit snugly.
3. Return to start position and select desired resistance.
4. Start movement by slowly extending backward with a smooth, controlled motion.
5. Slowly return to start position.

## BACK EXTENSION

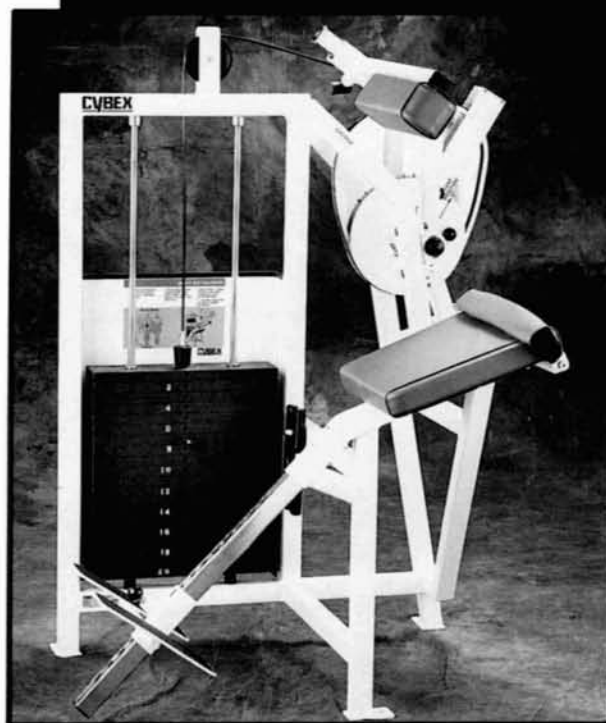

### SPECIFICATIONS:

Machine weight: 635 lbs.  
Weight stack: 400 lbs.  
Dimensions: 36" w x 46" l

Graduated weight stack also available.



4212

## MUSCLES TRAINED

Rectus Abdominus, Iliopsoas group

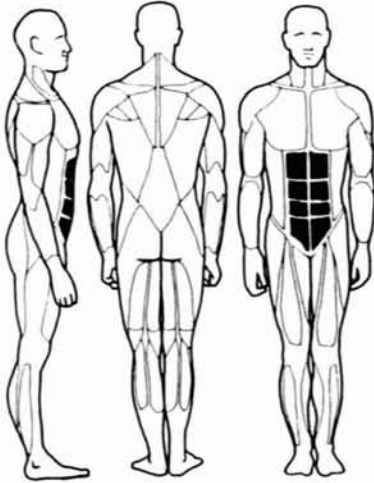

Rectus Abdominis

The CYBEX Abdominal machine offers user comfort and muscle loading variability by providing dual foot positions. Use of the front footplates simulates a crunch movement which focuses on the upper abdominals, while use of the rear foot pads promotes lower abdominal recruitment.

## INSTRUCTIONS

1. Adjust seat height so that chest pad is just below clavicle.
2. Select foot position. If front footplate is chosen, adjust its height so that knee angle is 90°.
3. Start movement by bending forward with a smooth, continuous motion.
4. Slowly return to start position.

## ABDOMINAL

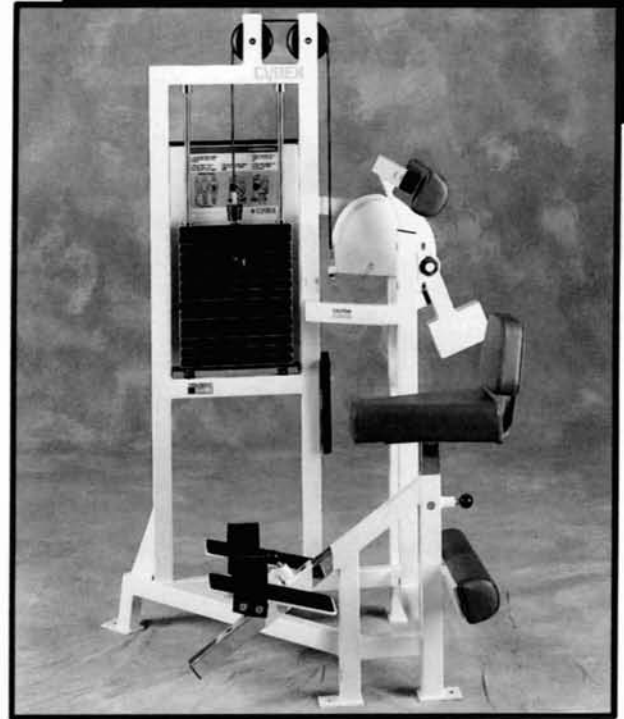

### SPECIFICATIONS:

Machine weight: 395 lbs.  
Weight stack: 187.5 lbs.  
Dimensions: 33" w x 42" l

Graduated weight stack also available.



## CHAPTER 3 - CUSTOMER SERVICE

### Ordering Parts

Replacement parts can be ordered by contacting CYBEX Customer Service (please specify inside sales support or technical support) at 1-888-462-9239 (1-888-GO CYBEX), Monday through Thursday 8:30 a.m. - 6:00 p.m. Eastern Standard Time and Fridays 8:30 a.m - 5:00 p.m. Having the following information ready when calling will assist our CYBEX representatives in serving you:

- **Unit Serial Number**
- **Product Name**

*The unit serial number and product name can be found on the serial number decal. Please refer to Chapter 5 of this manual for exact serial number location.*

- **Part Description**
- **Part Number**

*Part descriptions and part numbers are located in Chapter 5 of this manual.*

- **Upholstery Color**

*When ordering cushions or wear covers please be ready to provide the exact upholstery color required.*

- **Shipping Address**
- **Contact Name**

*In addition to your shipping address and contact name, your account number is helpful but not required.*

### CYBEX Limited Warranty

Cybox Strength products come with a limited parts warranty. Parts are warranted to be free from defects in materials and craftsmanship for the duration of the warranty period as follows below.

**Lifetime:** structural frame. *NOTE: This is applicable to the original owner only.*

**Five Years:** rotating bearings, guide rods, pulleys, cams and weight stacks.

**Three Years:** cables, bushings, linear bearings and other parts not listed.

**120 Days:** upholstery, and handgrips.

During the warranty period for each warranty described above, CYBEX promises to promptly replace or repair any defective part.

## **CYBEX Classic Owner's Manual**

There are no other expressed warranties on CYBEX products.

To the extent allowed by law.

1. This is a consumer transaction, any implied warranty of merchantability or fitness is limited to the duration of this written limited warranty. If this is a commercial transaction, all implied warranties (including without limitation, the implied warranties of merchantability and fitness for purpose) are specifically excluded.
2. CYBEX shall not be liable for any damages, including any incidental, indirect, special or consequential damages resulting from the use or condition of CYBEX products. The consumers sole and exclusive remedies for liability of any kind (including without limitation, direct or general damages) with respect to CYBEX products purchased shall be limited to the remedy provided in this warranty or at the sole option of CYBEX, a refund of the purchase price paid for such products.

Some states do not allow limitations on how long an implied warranty lasts or the exclusion or limitation of incidental or consequential damages, so the above limitations or exclusions may not apply to you.

This warranty gives you specific legal rights which may vary from state to state.

This warranty is limited to the original purchaser and is non-transferable.

In order to obtain performance of the warranty obligation, you may either call CYBEX toll free at 1-888-462-9239 (1-888-GO CYBEX) or you may mail your request to:

**CYBEX**  
10 Trotter Drive  
Medway, MA 02053

*No return of equipment will be accepted by CYBEX without a written RGA (Returned Goods Authorization) number. Freight charges on returns are the responsibility of the purchaser. Returns shipped freight collect will not be accepted. All prices are F.O.B. Factory in USA and subject to change without notice.*

## **CHAPTER 4 - DELIVERY & INSTALLATION**

We would like to take this opportunity to thank you for your purchase of CYBEX Strength Systems and to assure you that our commitment to excellence includes a dedication to customer service.

Freight and inside delivery charges cover trucking and handling costs necessary to place your equipment in any pre-determined location in your facility. This does not include unusual or special circumstances. If you purchased installation, your equipment will be assembled for you.

A thorough inspection of our CYBEX Strength Systems ensures that the equipment leaves our facility in flawless condition. Although unlikely, minor damage may occur in transit from our plant to your facility. Therefore, to guarantee that any damage is covered and then corrected, we ask that you follow the procedure below upon delivery to help ensure your satisfaction.

### ***Delivery Inspection***

Upon arrival, it is important that you thoroughly inspect all of the equipment for damage.

If you discover damage, point it out to the truck driver and request that the driver make a record of the damage on the receiving report. Be sure to obtain a copy of the receiving report for your files.

- Contact CYBEX Technical Support if you received damaged equipment and provide them with the information on the report regarding your damaged equipment.
- Contact CYBEX Inside Sales if you did not receive the appropriate equipment and provide them with the information regarding your order.

You may call CYBEX at 1-888-462-9239 (1-888-GO CYBEX) and specify if you are calling for a Technical Support Representative or an Inside Sales Representative.

### ***Installation***

Allow the appropriate operating space between machines. It is the responsibility of the purchaser to determine the appropriate operating space for customer safety and convenience. Do not crowd the exercise area.



## **Anchoring**

Anchoring machines provide maximum stability.

**Securely anchor each piece of Strength Systems equipment to the floor using the anchor holes provided with each machine.**

*NOTE: CYBEX is not responsible for the actual anchoring of equipment. Consult with a professional contractor.*

Use fasteners having a minimum of 500 lbs. tensile capacity (3/8" grade 2 bolts or better).

If all legs/frames do not contact surface, DO NOT pull down with anchors. Shim any leg or frame not in contact with surface with flat washers.

## **Safety**

Use extra caution when assembling and installing equipment, particularly when lifting or moving heavy objects (such as installing weight stacks) and when using power tools.

Before using any machine, read and understand the following material:

- Warning and caution labels
- Chapter 1 - General Exercise Guidelines
- Chapter 2 - Exercises
- Chapter 3 - Maintenance

## **Weight Stack Installation**

### **TOOLS REQUIRED FOR THIS PROCEDURE:**

- 5/16" Allen wrench
- Soft hammer

### **MATERIALS REQUIRED**

- Medium weight automotive engine oil.
1. Remove the two flat head socket cap screws (or socket head cap screws) securing the guide rods.
  2. Carefully lean guide rods away from weight stack guard on all machines except the Shoulder Internal/External Rotation and Wrist & Forearm machines. For these machines only, lean guide rods toward weight stack guard.
  3. Remove guide rod collets and plastic caps.
  4. Wipe guide rods clean over entire length. Lubricate with light coating of medium weight automotive engine oil.
  5. Install each weight plate, one at a time, beginning with highest numerical value. **NOTE:** *For 15 and 25 weight plate stacks, the first plate installed has no number.*
  6. Install top weight.
  7. Replace plastic caps and guide rod collets on guide rods.
  8. Return guide rods to full upright position.
  9. Insert both flat head socket cap screws removed in step 3 and tighten securely.
  10. Insert cable end into top weight and align cable fitting opening with opening in top weight for proper cable tension. *See Cable Adjustment and Installation section.*
  11. Using a hammer, drive roll pin through top weight cable connector holes and cable fitting. Assure pin is flush with top plate collar. See Figure 12 on next page.

12. Insert selector pin into each weight plate to assure proper alignment. If pin does not fit smoothly or if cable appears to have excessive slack, see *Cable Adjustment and Installation* section.

13. Place half weight on weight peg.

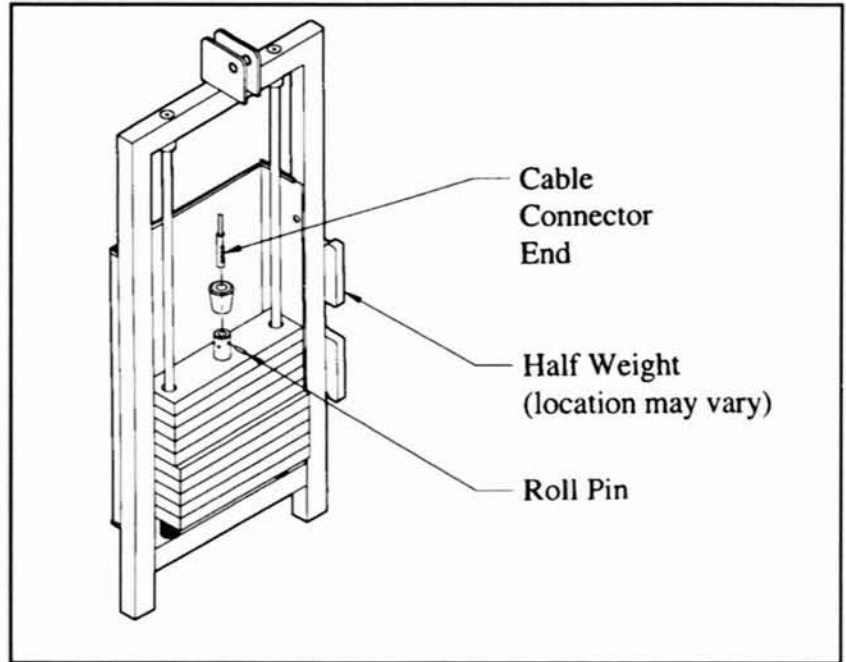

Figure 12

### ***Servicing Weight Stacks***

When requiring parts call CYBEX Customer Service at 1-888 462-9239 (1-888-GO CYBEX). See Figure 13 for top weight service information.

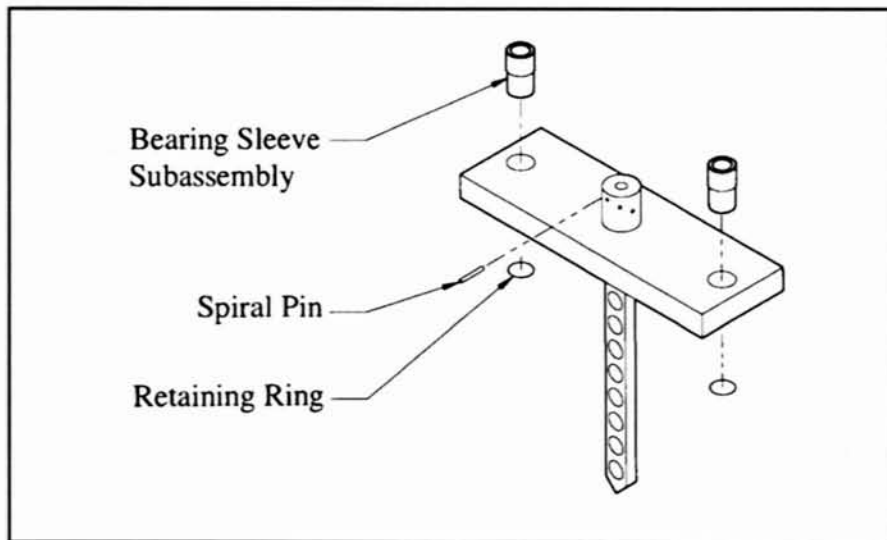

Figure 13

## CHAPTER 5 - MAINTENANCE

All preventive maintenance activities must be performed on a regular basis. Performing routine preventive maintenance actions can aid in providing safe, trouble-free operation of all CYBEX VR Strength Systems equipment.

*NOTE: CYBEX is not responsible for performing regular inspection and maintenance actions for your machines. Instruct all personnel in equipment inspection and maintenance actions and also in accident reporting/recording. CYBEX phone representatives are available to answer any questions or concerns that you may have.*



*NOTE: All inspections and repairs must be performed by trained service personnel only.*

**Cybex will void warranty if non-Cybex replacement parts are used or when unauthorized modifications are made.**

### *Daily Procedures*

- 1. Upholstery** - Wipe down all upholstery as per the recommendations listed below for light soiling and more difficult stains.

#### *Light Soiling*

- A solution of 10% household liquid dish soap with warm water applied with a soft damp cloth.
- If necessary, a solution of liquid cleanser and water applied with a soft bristle brush. Wipe away the residue with a water dampened cloth.

## *CYBEX Classic Owner's Manual*

### *More Difficult Stains*

- Dampen a soft white cloth with a solution of household bleach (sodium hypochlorite), 10 % bleach, 90% water. Rub gently. Rinse with a water dampened cloth to remove bleach concentration.
- The same procedure can be used with full strength household bleach, if necessary.
- Allow bleach to puddle on the affected area or apply with a soaked cloth for approximately 30 minutes. Rinse with a water dampened cloth to remove any remaining bleach concentration.

### *Alternative Method for Difficult Stains*

- Dampen a soft white cloth with rubbing alcohol and rub gently. Rinse with a water dampened cloth to remove any remaining rubbing alcohol concentration.

**NOTE:** To restore luster, a light coat of spray furniture wax can be used. Apply for 30 seconds and follow with a light buffing using a clean white cloth.

### *Please Review Carefully*

When using strong cleaning agents such as rubbing alcohol or bleach, it is advisable to first test in an inconspicuous area. Other cleaning agents may contain harsh or unknown solvents and are subject to formula changes by the product manufacturer without notice. Should you desire to use other cleaning agents, carefully try them in an inconspicuous area to determine potential damage to the material. Never use harsh solvents or cleaners which are intended for industrial applications. To clean stained or soiled areas, a soft white cloth is recommended. Avoid use of paper towels.

Cleaning products may be harmful/irritating to your skin, eyes, etc. Use protective gloves and eye protection. Do not inhale or swallow any cleaning product. Protect surrounding area/clothing from exposure. Use in a well ventilated area. Follow all product manufacturer's warnings. CYBEX and its vendors cannot be held responsible for damage or injuries resulting from the use or misuse of cleaning products.

2. **Frames** - Wipe down all frames using a mild solution of warm water and car wash soap. Be sure to dry thoroughly. **AVOID** acid or chlorine based cleaners and also cleaners containing abrasives as these could scratch or damage the equipment.
3. **Chrome** - Clean chrome tubes, first using chrome polish and then using a car wax seal. Neutral cleaners with a pH between 5.5 and 8.5 are recommended. Be sure to dry thoroughly. **AVOID** acid or chlorine based cleaners and also cleaners containing abrasives as these could scratch or damage the equipment.

**Weekly Procedures**

1. Inspect all nuts and bolts for looseness. Tighten as required.
2. Inspect all cables for wear or damage and proper tension. When inspecting cables, run your fingers on the cable, paying particular attention to bends in the cable and attachment points.

**Replace all worn cables immediately. The following conditions may indicate a worn cable:**

- A tear or crack in the cable sheath that exposes the cable. See Figure 1.

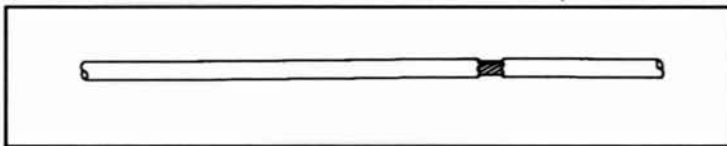

Figure 1

- A kink in the cable. See Figure 2.

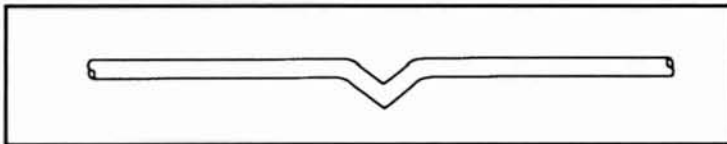

Figure 2

- A curled sheath. See Figure 3.

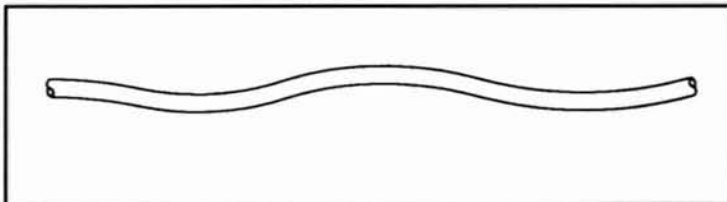

Figure 3

- "Necking", a stretched cable sheath. See Figure 4.

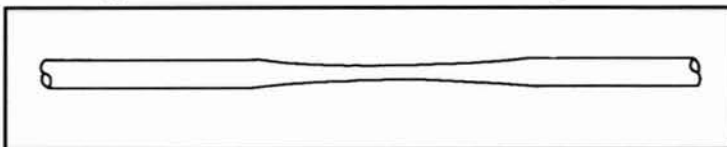

Figure 4

3. Check narrow grip handle attachment hole for wear. Replace if significant wear is visible. Do not use if less than 1/8" of material remains to the edge. See Figure 5.

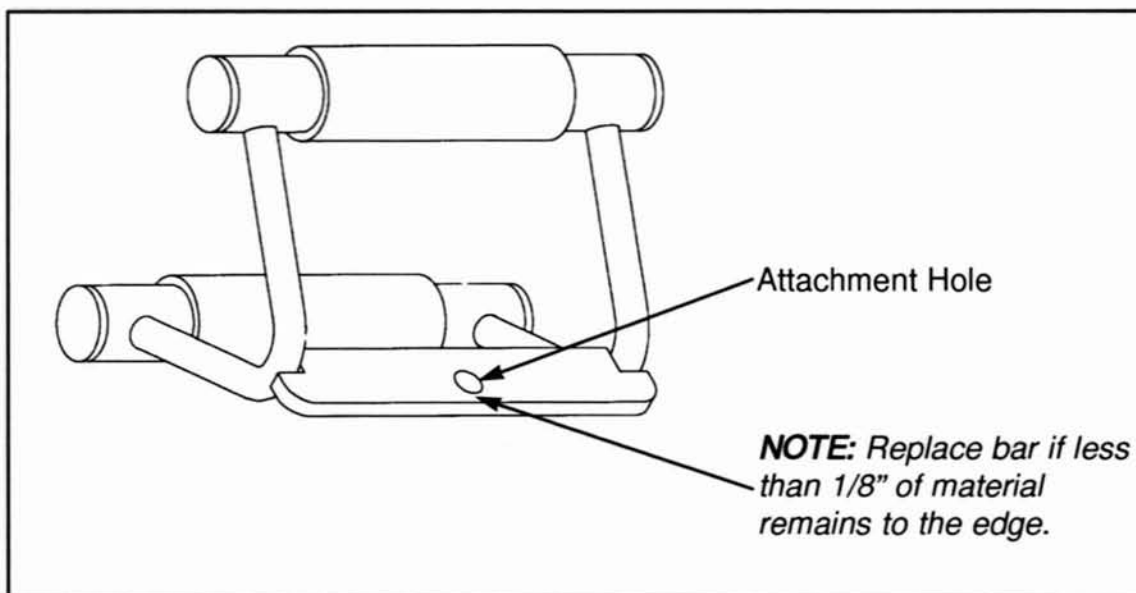

Figure 5

4. Inspect bars and handles for wear, paying particular attention to tab area connecting points.  
**Replace all worn handles immediately.**
5. Inspect snap links for proper latching (indicates wear).  
**Replace all worn snap links immediately.**
6. Inspect all labeling for readability. This includes instructional placards, warning and caution decals.  
**Replace all warning labeling immediately.**
7. Inspect all weight stacks for proper alignment and operation.  
**Correct all improper alignment and operation issues immediately.**
8. Wipe *Weight Stack Guide Rods* and *Leg Press Linear bearings* clean over entire length. Lubricate with a light coat of medium weight automotive engine oil.

## Yearly Procedures

Replace all cables at least annually.

## "As Required" Procedures

1. Inspect grips and replace as necessary.
2. Clean *Range Limiting Device* so that the cam tracks are wiped clean and lightly lubricated with a Teflon base spray lubricant (Superlube®).
3. Remove *Cable End Bearings* and lubricate thoroughly with a medium-weight automotive engine oil. To lubricate: Loosen rod end bearing jam nut with a 9/16" wrench. Using a 7/32" Allen wrench, remove the socket head cap screw (SHCS) and rod end bearing from unit. Coat bearing thoroughly with oil inside and out and reattach to unit.

## Cable Adjustment

Three types of cable tension adjustment are used on CYBEX Strength Systems:

1. **Jam Nut Adjustment** - This type uses a jam nut and a tension adjustment nut at the cable cam end as the primary adjustment. The other end of the cable usually contains a roll pin adjustment. See Figures 6 and 8.

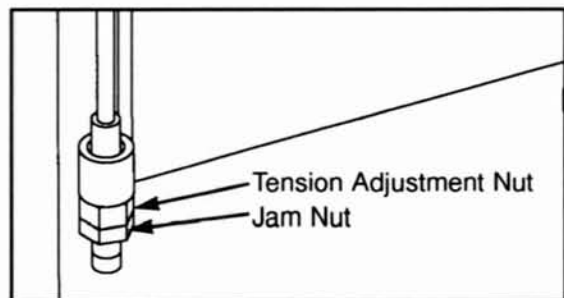

Figure 6



2. **Rod End Adjustment** - This type of adjustment contains a socket head cap screw (SHCS) securing a cable rod end bearing to the machine. Primary adjustment is by turning the rod end bearing. The other end of the cable usually contains a roll pin cable adjustment. See Figures 7 and 8.

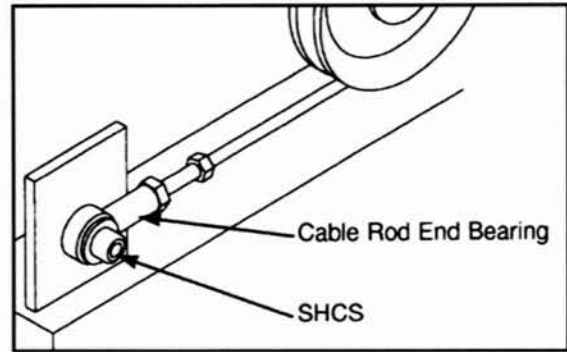

Figure 7

3. **Roll Pin Adjustment** - This type of adjustment utilizes a roll pin and series of holes in the weight stack top plate connector. See Figure 8.

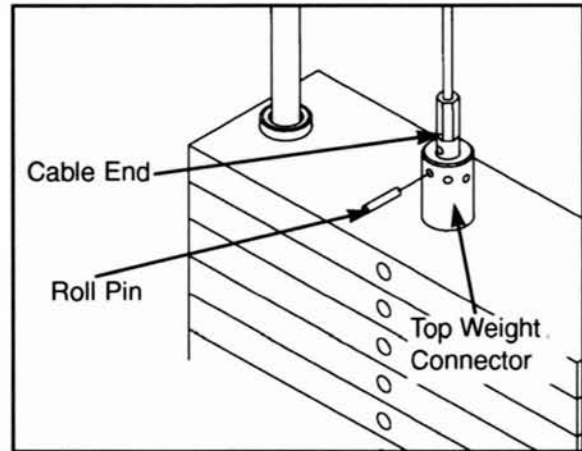

Figure 8

4. **Nylon Insert Nut Adjustment** - A single nylon insert nut at the cable or frame attachments used for alignment. See Figure 9.

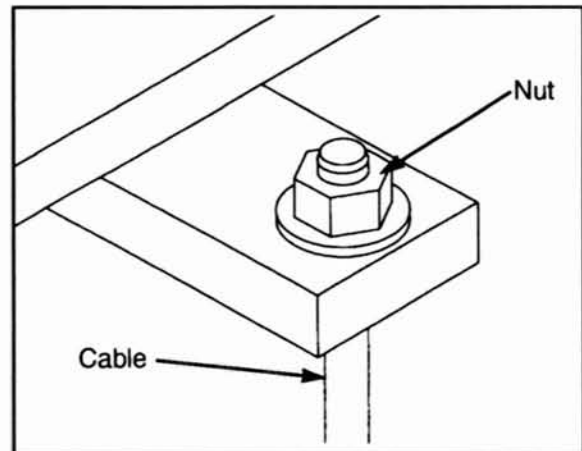

Figure 9

### **Cable Tension Check**

*NOTE: Assure weight stack top plate is flush with weight stack prior to, and during, cable tension check.*

1. Select a point on the cable half way between weight stack and pulley.
2. Push cable right or left. Cable deflection greater than 3/4" (1" for RLD units) indicates excessive slack. Deflection of 1/4" to 3/4" (1/2" to 1" for RLD units) is normal, as is a slight increase in slack between checks. See **Cable Tension Adjustment** to adjust tension.

*NOTE: The correct cable tension is critical for proper range limiting device (RLD) operation. If cable is too tight, RLD start position will be difficult to adjust.*

### **Alternative Cable Tension Check**

1. Select top weight plate (using weight selector pin).
2. Slowly raise and lower top weight plate (in normal fashion).
3. Verify top weight plate is just resting on second plate.

*NOTE (1): If there is too much tension then the top weight plate will not properly rest on second weight and the weight stack selector pin may be difficult to insert into weight plates.*

*NOTE (2): Too much slack is indicated if top weight plate does not lift immediately after raising top weight plate (in normal fashion). A slight slack in cable is ok.*

*NOTE (3): The correct cable tension is critical for proper range limiting device (RLD) operation. If cable is too tight, RLD start position will be difficult to adjust.*

4. Adjust cable if there is too much tension or too much slack. See **Cable Tension Adjustment** to adjust tension.

*NOTE: The roll pin adjustment for RLD units should be one to two holes looser than for non-RLD units.*

## Cable Tension - Jam Nut Adjustment

### TOOLS REQUIRED FOR THIS PROCEDURE:

- 11/16" Open end wrench (2 required)

**NOTE:** For cables with a jam nut adjustment at one end and a roll pin adjustment at the other end, you must perform the jam nut adjustment to correct cable tension. Perform roll pin adjustment if rod end adjustment does not provide proper tension.

**NOTE:** Cable ends on some equipment are covered by protective plastic caps. Remove and replace caps as required.

1. Using a 11/16" open end wrench, hold cable tension adjustment nut. With a second 11/16" open end wrench, loosen cable jam nut. See Figure 6.
2. To increase cable tension, tighten cable tension adjustment nut clockwise several turns. To decrease tension, loosen nut counter-clockwise several turns.
3. Test cable tension (see **Cable Tension Check**). Deflection of 1/4" to 3/4" indicates proper tension. If top weight plate does not rest securely against the second plate and selector pin cannot be fully inserted, there is too much tension on the cable. After adjustment, retest tension and selector pin fit.
4. When deflection is within limits; using an 11/16" open end wrench, hold cable tension adjustment nut. Using a second 11/16" wrench, tighten jam nut.
5. If correct cable tension cannot be achieved, perform roll pin adjustment per **Roll Pin Adjustment** section.

## Cable Tension - Rod End Adjustment

### TOOLS REQUIRED FOR THIS PROCEDURE:

- 9/16" Open end wrench
- 7/32" Allen Wrench

**NOTE:** For cables with a rod end adjustment at one end and a roll pin adjustment at the other end, you must perform the rod end adjustment to correct cable tension. Perform roll pin adjustment if rod end adjustment does not provide proper tension.

1. Using a 9/16" open end wrench, loosen jam nut on rod end bearing several turns. See Figure 10.

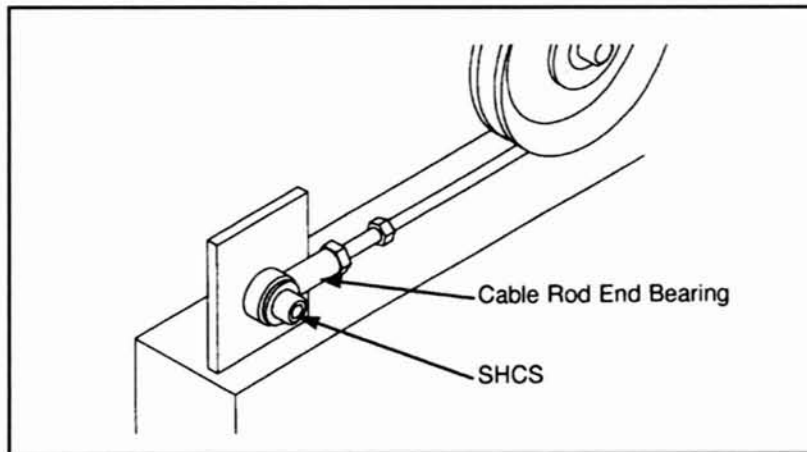

Figure 10

2. Using a 7/32" Allen wrench, completely remove socket head cap screw (SHCS) from assembly so that rod end bearing is free to be adjusted.
3. To increase cable tension, turn rod end bearing on threaded cable end clockwise. To decrease cable tension, turn rod end bearing counter-clockwise.
4. Using a 7/32" Allen wrench, attach rod end bearing to frame with SHCS.

5. Test cable tension (see **Cable Tension Check**). Deflection of 1/4" to 3/4" indicates proper tension. If top weight plate does not rest securely against the second plate and selector pin cannot be fully inserted, there is too much tension on the cable.
6. Remove rod end bearing to readjust if required. Install rod end bearing. Check tension and selector pin fit.
7. When deflection is within limits, using a 9/16" open end wrench, tighten rod end jam nut.
8. If correct cable tension cannot be achieved, perform roll pin adjustment per **Roll Pin Adjustment** instructions.

### **Cable Tension - Roll Pin Adjustment**

#### **TOOLS REQUIRED FOR THIS PROCEDURE:**

- 3/16" Punch
- Hammer

1. Slide protective rubber cover up cable to expose cable/plate junction. Note roll pin location in cable fitting. See Figure 11.

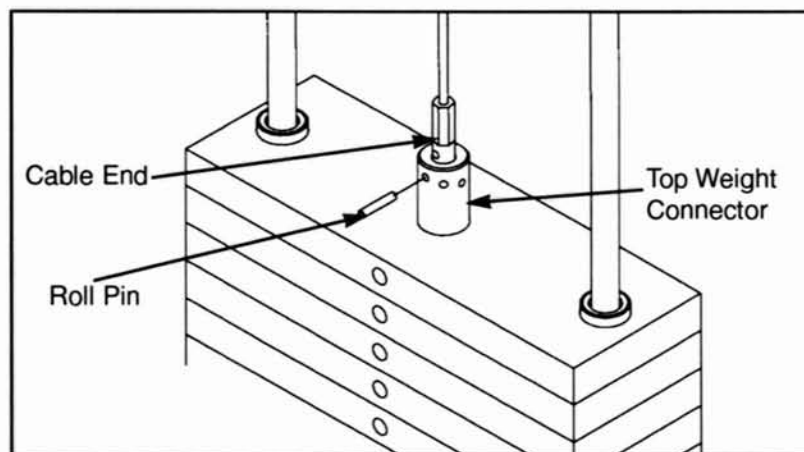

Figure 11

## *CYBEX Classic Owner's Manual*

2. Using a 3/16" pin punch and hammer, drive roll pin out of top plate connector and cable fitting.
3. Grip cable fitting firmly, pull down to tighten cable. Rotate fitting to align roll pin hole with an opening in top plate connector.
4. Insert pin punch through top plate connector and roll pin hole to hold cable in place.
5. Drive roll pin through top plate connector and fitting from opposite side, pushing out pin punch. Assure roll pin ends are flush.
6. Test cable tension (see **Cable Tension Check**). Deflection of 1/4" to 3/4" indicates proper tension. If top weight plate does not rest securely against the second plate and selector pin cannot be fully inserted, there is too much tension on the cable.
7. To readjust, if required, drive pin out of top plate connector and realign any cable fitting pin hole with another connector opening as required to adjust tension. Check that roll pin is flush. If cable tension cannot be corrected, contact a CYBEX Customer Service Technician.
8. Once proper tension is achieved, fully inset selector pin and replace protective cover over cable fitting.

### *Nylon Insert Nut Adjustment*

#### **TOOLS REQUIRED FOR THIS PROCEDURE:**

- 7/16" Open end wrench
- Pliers

**NOTE:** *The cable tension adjustment nut is locked by a nylon insert.*

1. Grip lower section of cable fitting with pliers and tighten adjustment nut clockwise with a 7/16" open end wrench. Make small incremental adjustments. See Figure 9.
2. Check cable tension (see **Cable Tension Check**). Deflection of 1/4" to 3/4" indicates proper tension.
3. Readjust and retest if required. If cable tension cannot be corrected then contact a CYBEX Customer Service Technician.